



Architectural
solutions
in zinc

Designing with elZinc®

elZinc®

Because **zinc** doesn't
have to be **grey**...

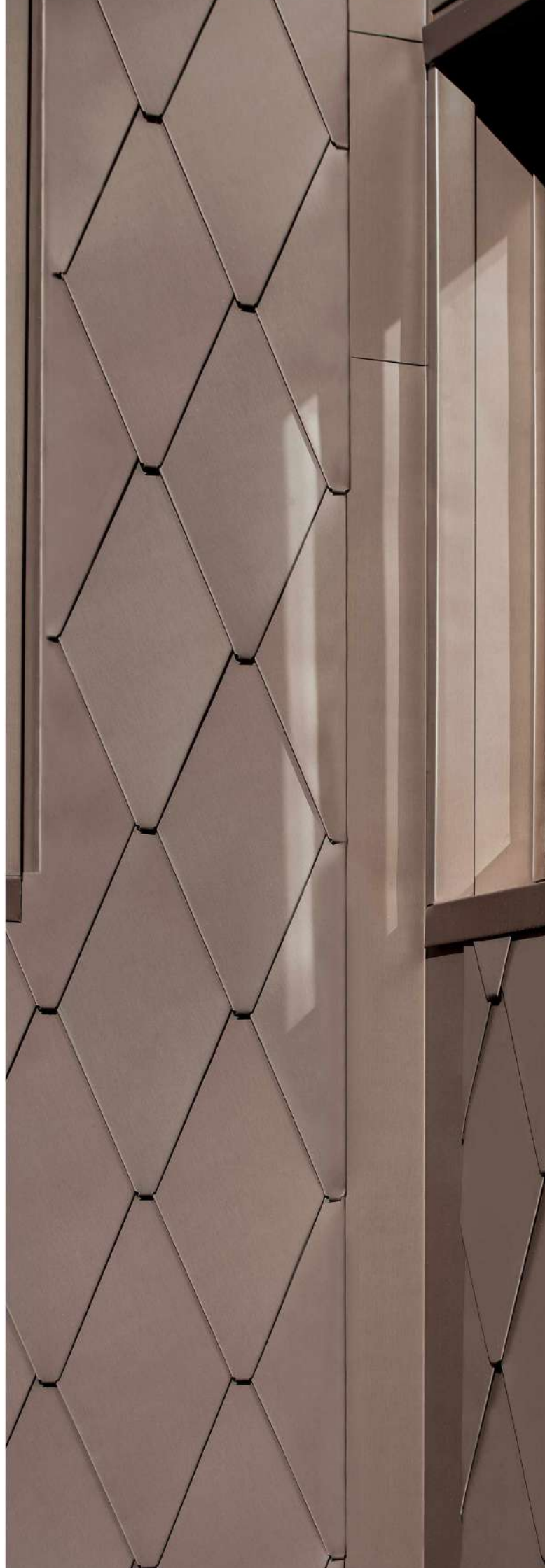

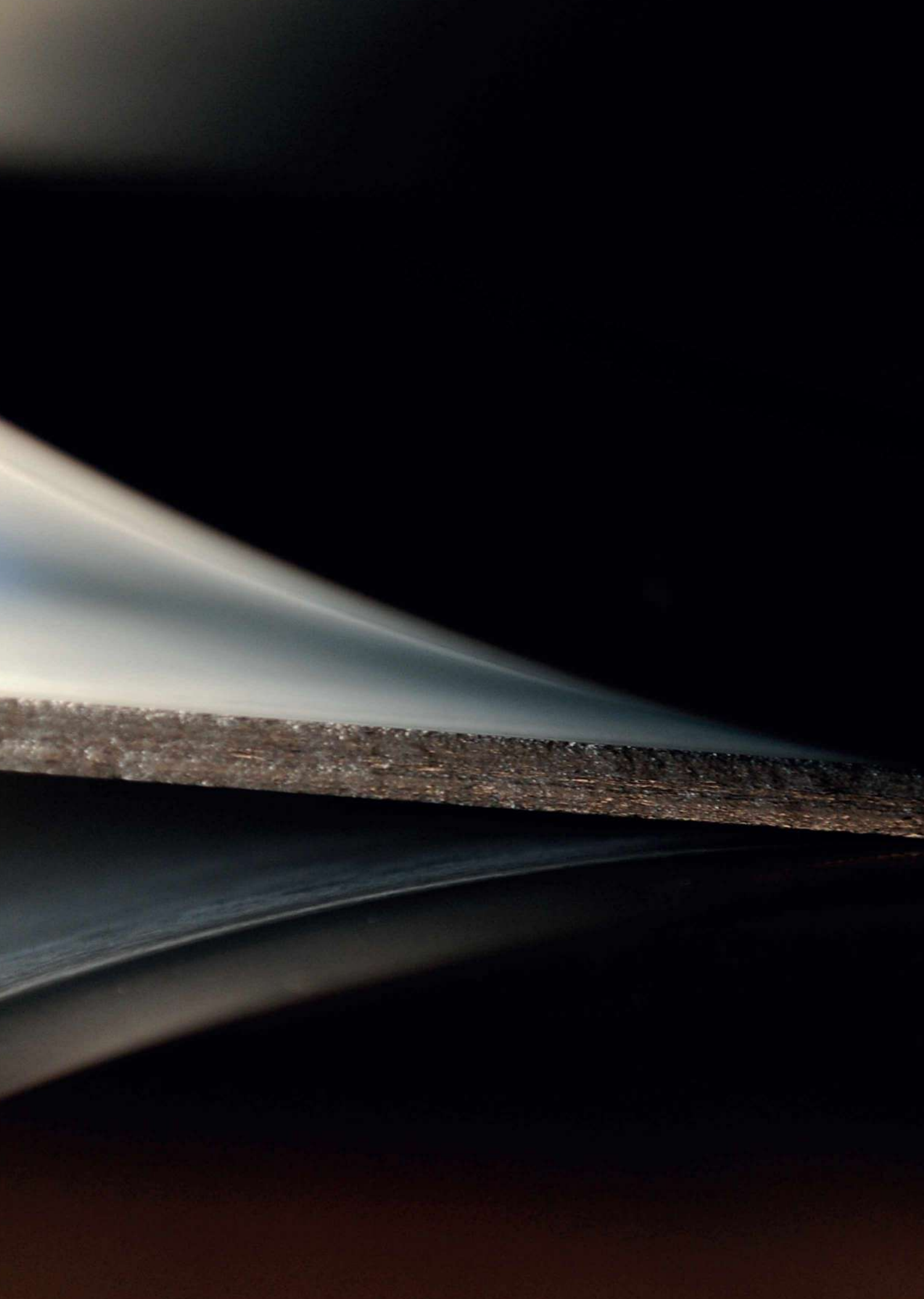

Prologue

Many years ago, when I visited the coal mine at Arnao (Avilés), I found that the most important buildings were roofed in zinc. The domes and cornices of the old headquarters of the Royal Company in the Spanish Square in Madrid that were covered in zinc over a century ago also made a strong impression on me.

To personally promote the numerous advantages of zinc in architecture, 18 years ago I had a dream: to create the largest and most modern zinc rolling mill in the world, able to offer the highest quality and widest range of finishes to architects wishing to use zinc, or rather, **elZinc®**.

Dear architects, partners and clients... thanks to you all this dream is becoming a reality.



Macario Fernández Fernández
Chief Executive Officer - Asturiana de Laminados S.A.

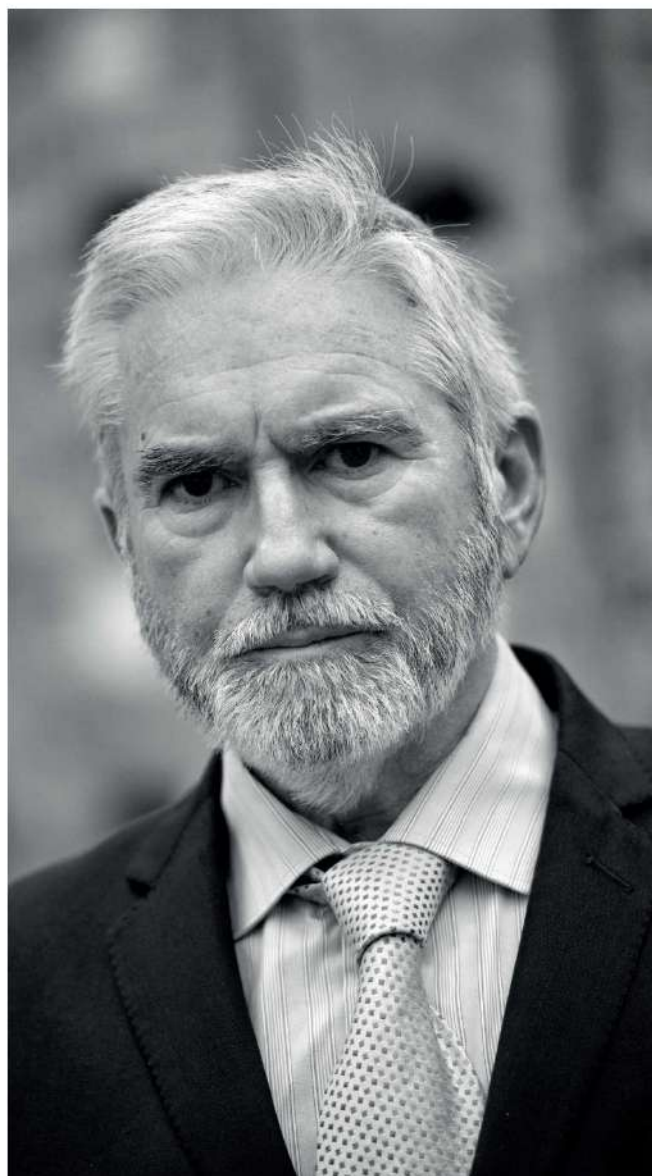

Index

■ Why choose elZinc® for your projects?	Pag. 8
■ elZinc®: a sustainable building material	Pag. 10
■ The Company	Pag. 13
■ Quality	Pag. 14
Our quality assurance	Pag. 15
Product properties	Pag. 16
■ Finishes and formats:	Pag. 18
elZinc Alkimi®	Pag. 20
- elZinc® Natural	Pag. 22
- elZinc Slate®	Pag. 24
- elZinc Graphite®	Pag. 26
- elZinc Crystal®	Pag. 28
- elZinc Oliva®	Pag. 30
- elZinc Lava®	Pag. 31
elZinc Rainbow®	Pag. 32
elZinc Advance®	Pag. 34
elZinc Protect+®	Pag. 36
Delivery Program for standard coils and sheets	Pag. 38
elZinc® Tiles	Pag. 40
elZinc® honeycomb panel	Pag. 42
elZinc® composite	Pag. 44
■ Systems:	Pag. 46
Traditional systems	Pag. 49
- Double lock standing seam	Pag. 54
- Angle standing seam	Pag. 60
- Flat lock shingles	Pag. 64
- elZinc® Tiles	Pag. 68

Engineered façades	Pag. 75
- Façade panel	Pag. 78
- elZinc® Composite material	Pag. 82
- elZinc® Honeycomb panel	Pag. 84
■ Envelope construction	Pag. 86
Traditional systems	Pag. 89
- Underlays generally	Pag. 90
- The substrates	Pag. 91
- Compatibility with other building materials	Pag. 93
- Thermal design	Pag. 96
- Examples of roof types	Pag. 98
- Examples of unvented roofs	Pag. 102
- Examples of ventilated façades	Pag. 104
Engineered façades	Pag. 109
■ Rainwater Systems	Pag. 114
Eaves gutters rainwater systems	Pag. 118
Parapet and internal gutters	Pag. 122
■ Services	Pag. 124
Technical and commercial assistance	Pag. 126
Appendix	Pag. 128

The Alchemist, Manchester, UK.
Reid Architects



Why choose elZinc® for your projects?

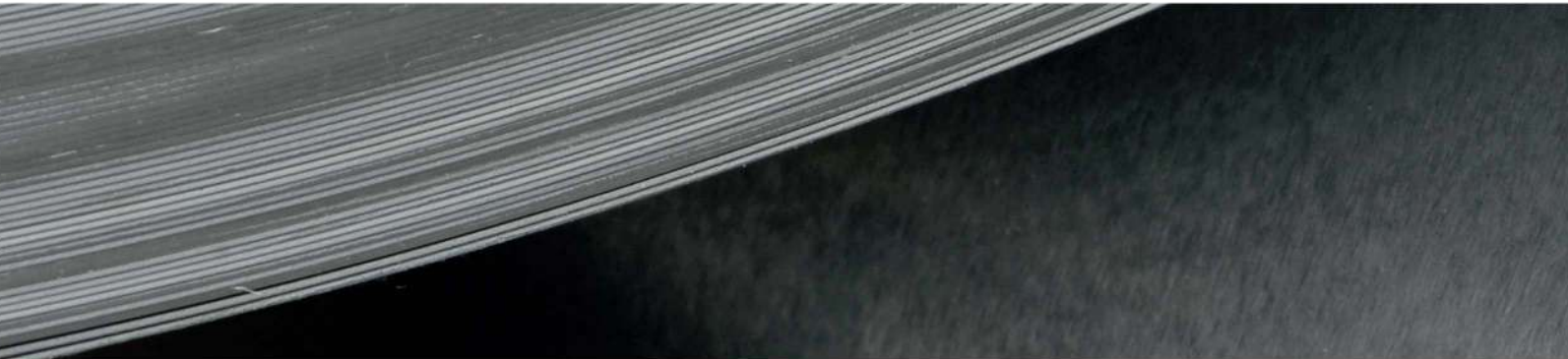

Designing in zinc frees your imagination

Zinc has been used as a roofing and façade cladding material since the 19th century thanks to the numerous esthetic and functional qualities it possesses and which allow its adaptation to all architectural styles.

Its natural surface and changing reflections make it an extraordinarily versatile material.

Titanium-zinc from **elZinc®** can blend into its surroundings or, on the contrary, highlight the unique character of a facade, depending on the intended effect. Its excellent malleability and the adaptability of the systems used to install it enable **elZinc®** to conform to the most complex and unusual geometries.

It can be installed both on low pitched roofs (with a minimum of 3°) as well as on façades.

The wide range of surface finishes produced by **elZinc®** and the numerous possible combinations, as well as the many types of installation systems available nowadays, offer a host of possibilities for the inside and outside of buildings.

510 West Building, New York, USA – Cook Fox.



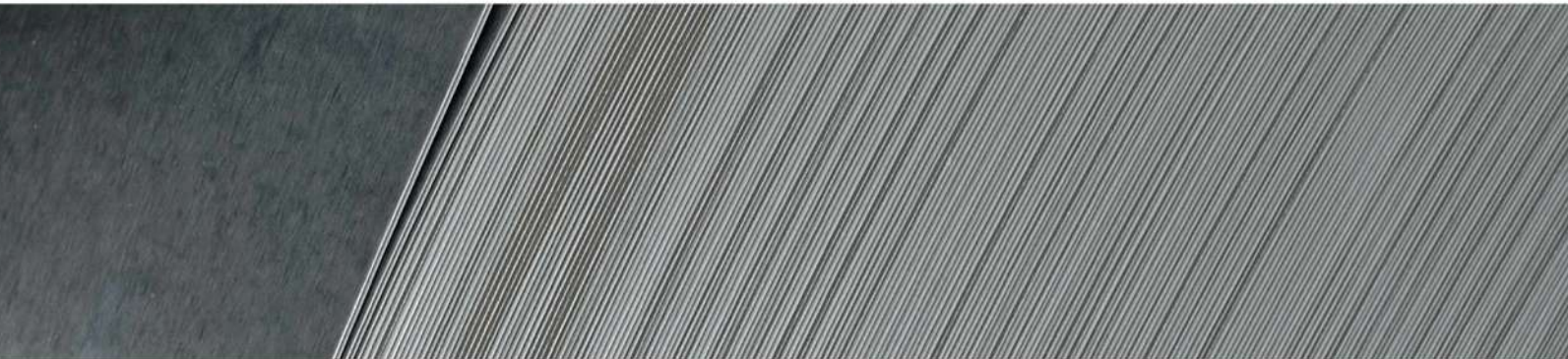

Building with elZinc® guarantees exceptional durability

Designed to endure, titanium-zinc from **elZinc®** is a long-lasting material that maintains its initial properties intact over the lifetime of the building.

One of most significant properties of zinc is its high corrosion resistance. In rural areas (where pollution is low) its service life can be well in excess of a hundred years.

Titanium-zinc is a living material, and develops a self-healing patina throughout its lifetime that continually protects it and confers to it a characteristically unique appearance.

Once in place, the result is a durable, resilient external building skin practically impervious to the worst the weather can throw at it.

The combination of just a few of the advantages of zinc - its long life service, lack of special maintenance and its lightness (between 7 and 10kg/m² which can help reduce the costs of the building's structure) - makes zinc a sound economical choice.

Choosing **elZinc®** as the building envelope's skin is not only selecting a natural and attractive material, but also ensuring long term protection.

Auditorium, Plabennec, France - Mostini Architects.



elZinc®: a sustainable building material



elZinc®: the natural solution

Zinc is a natural element which is found throughout the earth's crust in plentiful supply.

Zinc is essential for the survival of any living organism. Its use in construction is environmentally-friendly.

Zinc is one of the few building materials that are 100% reusable and recyclable for an unlimited number of times. Each recycling process takes away none of the mechanical and chemical properties that make it such a high-quality material.

Zinc is primarily mined in China, Peru and Australia. However, more than 30% of world production comes from recycled material. In this way, its use contributes to preserving other natural resources, saving energy consumption, reducing greenhouse gas emissions, whilst the exploitation of existing zinc reserves is kept to a minimum.

Note: All by-products and zinc waste generated during the elZinc® production process are reused and recycled. Having gone through the required quality controls, the scrap zinc is re-melted and rolled again in the same productive process. Regarding alternative byproducts, such as zinc oxide, they are used for other industrial applications.

Once installed, elZinc® doesn't need any special maintenance, therefore reducing its ecological impact.

The production process is less energy intensive than other metals used in construction. Indeed, it is significantly less than that of aluminium and copper:

Aluminum 255 MJ/kg – 482 MJ/m ²	0.7mm thick aluminum
Copper 70 MJ/kg – 375 MJ/m ²	0.6mm thick copper
Zinc 51 MJ/kg – 238 MJ/m ²	0.65mm thick zinc

Source: 'Sustainable Construction: Green Building Design and Delivery'

Hotel, Poland.





Our ecological footprint: Environment product declaration

Building professionals that intend to carry out an evaluation of the environmental impact of their building need an Environmental Product Declaration of the products they plan to use, that recognizes and proves their environmental credentials.

To this end, **elZinc®** has put at your disposal Environmental Product Declarations « EPD » for its **elZinc Alkimi®** range which includes *elZinc Natural*, *elZinc Slate®*, *elZinc Graphite®*, *elZinc Crystal®*, *elZinc Oliva®* and *elZinc Lava®*, calculated in accordance with the International standard ISO14025.

The analysis of the life cycle of **elZinc®** products is the cornerstone of this project, putting at the fingertips of experts who pursue a policy of sustainable building management all the relevant information regarding the environmental impact of its products, in a broken down and verifiable manner.

The natural advantages of the material together with the productive intelligence of **elZinc®** offer many different and interesting solutions for sustainable building projects, both for new-build and refurbishment.

Resource-optimising management

	1 kg elZinc® Natural	1 kg elZinc Slate®
GWP1 (kg CO2-Eq)	3,5	3,7
ODP2 (kg CFC11-Eq)	3,3 x 10-7	3,3x 10-7
AP3 (kg SO2-Eq)	2,3 x 10-2	2,3 x 10-2

1. Global warming potential.
2. Ozone-depleting potential.
3. Acidification potential.

Asturiana de Laminados, S.A., manufacturer of **elZinc®**, has implemented a comprehensive performance programme for the optimization of consumption and the reduction of waste, based on the following elements:

- A sustainable purchasing policy and the location of our main supplier of raw materials located in the same region (Asturias) as our facilities ensure minimal environmental impact from transport.
- The use of the latest generation of manufacturing technology which gives the most efficient use of raw materials and reduces energy consumption even further.

If you need more information regarding the implications of choosing an elZinc® product on the environmental certification process LEED, don't hesitate to consult our technical department and/or visit our webpage.



The company

Established in 2006, Asturiana de Laminados, S.A. by virtue of its **elZinc®** brand, has become one of the world's main producers of rolled zinc products.

The use of the latest technologies in casting, rolling, slitting and cutting coupled with the implementation of the most rigorous quality control protocols, allows **elZinc®** to better the tolerances established in the current European and American standards, namely EN988 and ASTM B-69.

Our success is founded upon a constant drive to progress and to satisfy the most demanding of market needs. Thanks to the work carried out in R&D&I, we offer a wide range of roofing and cladding products and finishes, and are already present in more than 45 countries.

More than a 120 professionals place their expertise at your disposal, providing customized technical and commercial assistance aimed at construction professionals that may require it in any part of the world.



Our quality assurance



Using elZinc® in your projects guarantees a long lasting result and an impeccable finish

Our commitment to our customers and the constant strive to improve our products and services is one of the pillars of our Quality Policy.

Our experience together with the use of cutting edge technology allows us to offer quality products that exceed the requirements established by standards **EN 988 and ASTM-B69**, in which the specifications rolled zinc alloys for use in construction are defined.

Through the optimization of the rolling process's operating parameters and meticulous temperature control during all of the various production stages, **elZinc®** has developed a product of excellent quality suitable for different applications in building.

The rigorous Quality Controls continuously conducted by our own laboratories and by prestigious independent experts maintain and attest to the Quality of our material.

elZinc® is the highest quality rolled zinc alloy available in the market, which has been tested by the standards

elZinc®'s products are characterized by:

- ▣ Very good workability irrespective of the direction of rolling.
- ▣ High resistance to creep (creep strain limit).
- ▣ Low cold brittleness.
- ▣ Optimal electro-welding performance due to its low surface oil content.



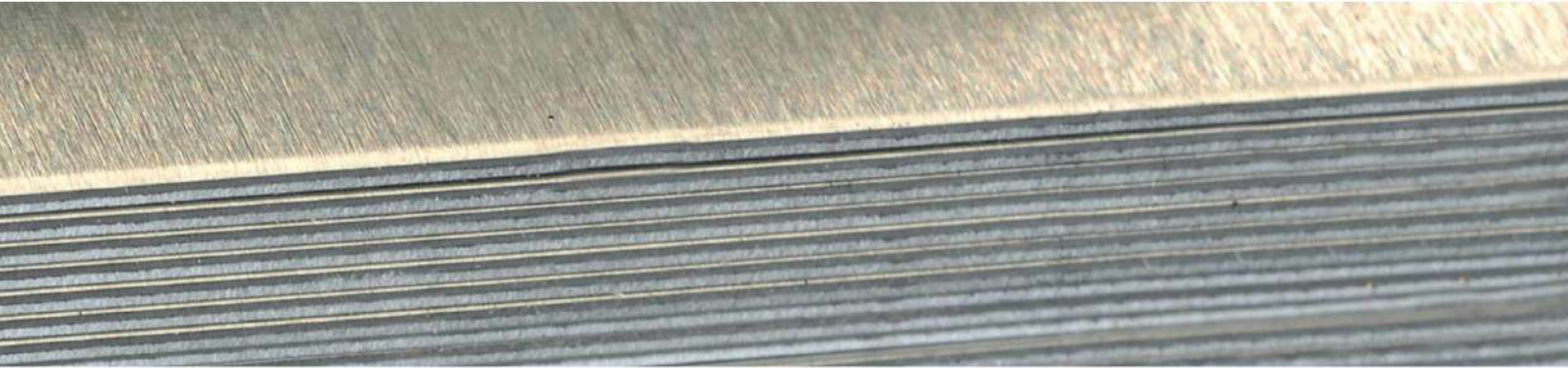

eIZinc® has put into place numerous management tools that reinforce this quality guarantee:

■ **Quality certificate according to standard UNE-EN ISO 9001:2008**

From its origins, Asturiana de Laminados, SA -eIZinc®- has submitted itself to an ongoing process of improvement that has been accredited and endorsed by the internationally recognized standard for quality management UNE-EN ISO 9001.



TÜV SUD Quality Management System

■ **Internal and external quality controls.**

The rigorous Controls continuously conducted by our own laboratories and by prestigious independent experts maintain and attest to the quality of our material.

■ **The identification of our products.**

All eIZinc® sheets and coils are identified with a serial number to ensure traceability. This automatic marking on the inside surface of the metal guarantees product traceability and the identification of the material.

■ **Komo Certificate.**

eIZinc® has been awarded the prestigious Komo Certification for the eIZinc® Natural, Slate®, Graphite® and Rainbow® range of products. This document certifies, having undergone the thorough examination associated with the Komo mark, that the rigorous quality control procedures established by eIZinc® in all of its industrial procedures ensure the highest possible quality of products.

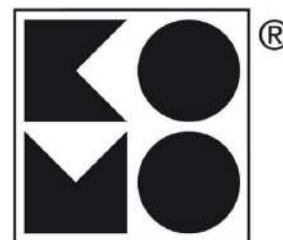

KOMO Certificate

Product properties

Test criteria for elZinc's standard rolled zinc:

PARAMETER	CRITERIA elZinc®	CRITERIA EN988	CRITERIA ASTM B-69
CHEMICAL COMPOSITION			
Zinc	Zn 99,995 (Z1 according to EN 1179)	Zn 99,995 (Z1 according to EN 1179)	-
Pb, Fe, Cd, Sn, Mn y Mg	-	-	Max. 0,005 %
Copper	0,08-0,2%	0,08-1,0%	0,08-0,2 %
Titanium	0,07-0,12%	0,06-0,2%	0,07-0,12 %
Aluminium	≤0,015%	≤0,015%	0,001-0,015 %
DIMENSIONS / TOLERANCES FOR STANDARD PRODUCTS			
Thickness of sheets/coils	± 0,01mm	± 0,03mm	±0,0254 mm* ±0,0508 mm**
Width of sheets/coils	+ 1/-0mm	+ 2/-0mm	±1,575 mm
Length	+2/-0mm	+10/-0mm	±5 mm
Edgewise bow	≤1,0 mm/m	≤1,5 mm/m	25,4 mm/3048 mm (arc radius 45,7 m)
Flatness	≤2 mm	≤2 mm	-
MECHANICAL AND TECHNOLOGICAL PROPERTIES IN THE DIRECTION OF ROLLING			
Yield strength elasticity 0,2 % (Rp 0,2)	>110 N/mm ²	>100 N/mm ²	-
Tensile strength (Rm)	>150N/mm ²	>150N/mm ²	96 - 262N/mm ²
Breaking elongation (A50)	≥40%	≥35%	10-70 %
Vickers hardness (HV3)	≥45	-	-
HR15T hardness	-	-	54-74
Bending test	No cracks at the edge of fold	No cracks at the edge of fold	-
Bending back after folding test	No cracks	-	-
Erichsen test	Min.7,5mm	-	-
Deformation after yield strength test (Rp0, 1)	≤0,1%	≤0,1%	-

*for thicknesses between 0,254 y 0,762mm

**for thicknesses between 0,762 y 1,524 mm



3. Finishes and formats





elZinc Alkimi®

Pure elegance

Zinc cladding and roofing allows a great deal of freedom when designing. The **elZinc Alkimi** aesthetic finishes give character and authenticity to your architectural projects.

Manufactured from elZinc Natural, according to EN988 and ASTM B-69 standards, through a unique surface treatment carried out with elZinc technology and know-how, the **elZinc Alkimi** range respects and maintains intact the zinc's original properties.

Zinc cladding and roofing contributes to create a unique style and confers undeniable aesthetic value to buildings.

Used alone or combined, the shades that compose **elZinc Alkimi** - currently the widest on the market - reveal the shapes, the volumes and the textures of architecture.

elZinc Alkimi® finishes range:

elZinc® Natural



elZinc Slate®



elZinc Graphite®



elZinc Crystal®



elZinc Oliva®



elZinc Lava®



Tongliao Arts Center, Neimenggu, China.





elZinc® Natural

Product description:

elZinc® Natural is the original metallic grey finish produced by our manufacturing process.

Once exposed to the elements, **elZinc®** Naturally develops a compact protective layer called “patina”. This patina provides exceptional resistance to corrosion, resulting in the gradual loss of its metallic luster until it takes on its characteristic matt grey colour.

The final shade of the colour largely depends on the environmental conditions to which it is exposed, as particulate matter and dust in the air are drawn into the patina.

Cruise terminal, Bilbao, Spain.





The house on the edge, Granada, Spain - Gil Bartolome Architects

elZinc Slate®

Product description:

elZinc Slate® is a pre-patinated matt grey zinc having a very similar appearance to naturally weathered zinc.

The pre-weathering is performed using a non-polluting phosphate treatment that gives it a uniform appearance that would have been achieved after several years of exposure to the open air, whilst preserving its initial properties.

elZinc Slate® is used in roofing and cladding, where it harmonizes perfectly with other traditional building materials, or indoors, where a natural patina would take much longer to form. It is also especially appreciated in restoration and renovation since its initial colour allows it to blend in easily with existing weathered zinc.

Its attractive texture combines perfectly with most building materials (wood, stone, slate), giving rise to a long lasting harmonious appearance.

La Boqueria Market Place, Barcelona, Spain.
Estudio Carme Pinos.





elZinc Graphite®

Product description:

elZinc Graphite® is architectural zinc pre-weathered to a very dark, almost black shade of grey.

The pre-weathered finish is achieved using a non-polluting phosphate treatment that preserves and respects the initial properties of zinc.

Bringing to the fore the cladding's lines in a refined fashion, it is appreciated for its purity and sobriety.

Combined with other traditional materials such as wood or glass, it allows the creation of stylish and long-lasting façades which maintain their original elegance as time passes by.

Eugene Varlin School, Pierrefitte-Sur-Seine, France.
Gaëtan Le Penhuel & Associés.



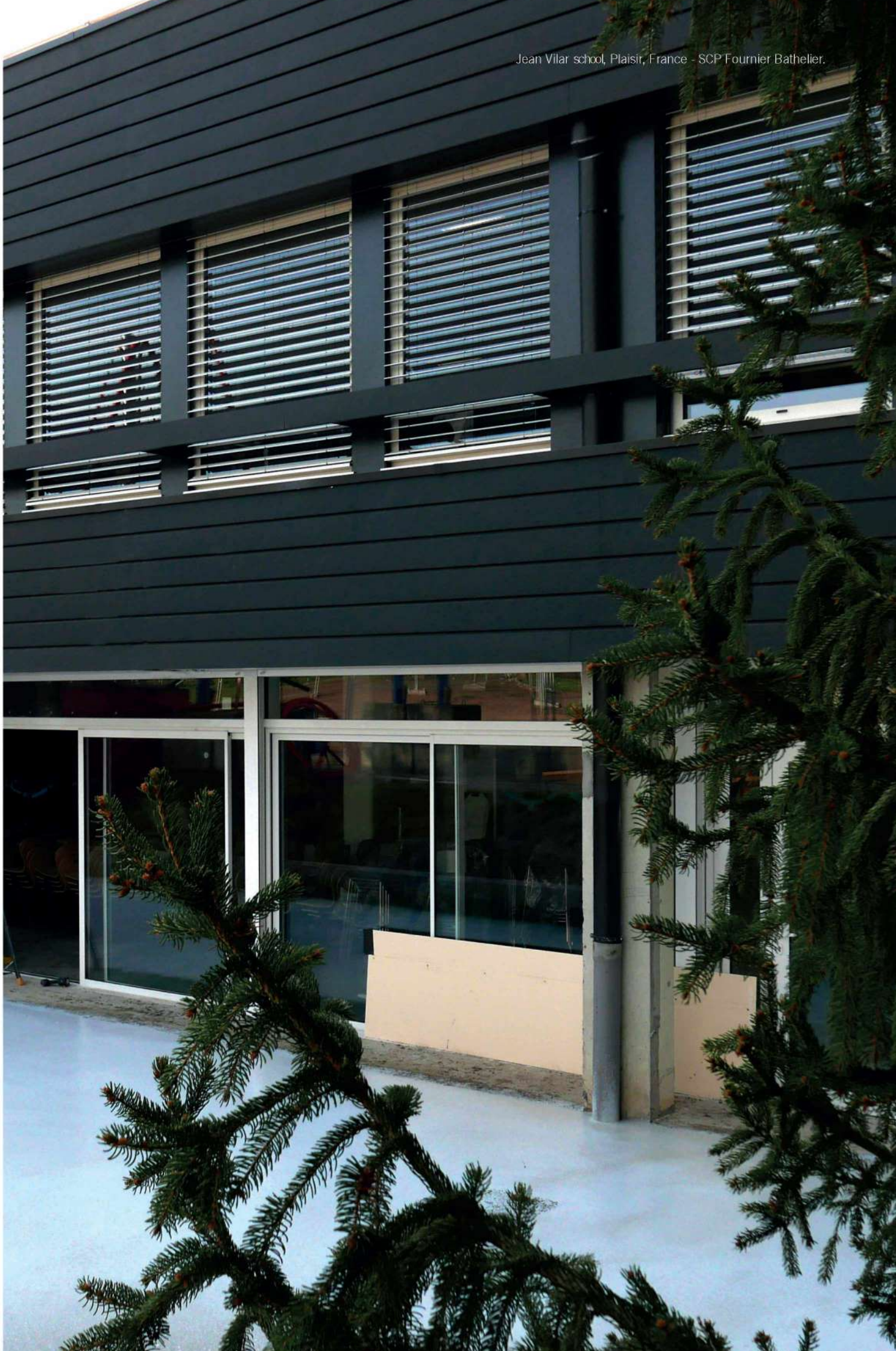

elZinc Crystal®

Product description:

elZinc Crystal® is a new pearl grey pre-patinated zinc. Its changing reflections play with light and give it a different look depending on its exposure. It creates striking effects that personalize your façades.

The pre-weathered finish is achieved using a non-polluting treatment that preserves and respects the base properties of zinc.

Modern yet timeless, **elZinc Crystal®** helps you to create truly unique architecture.

Lady Bee Marina, Shoreham, England.
ECE Architecture.





elZinc Oliva®

Product description:

elZinc Oliva® is a dark grey pre-weathered zinc with subtle greenish and bluish hues. These contemporary tones guarantee a natural and balanced contrast with the surrounding environment.

The pre-weathered finish is created using a surface treatment that maintains intact the zinc's original properties.

Subtle and sophisticated, **elZinc Oliva®** enhances any building's appearance with unique and personalized aesthetics.

Leemington Spa, England.
Rickett Architects Ltd.

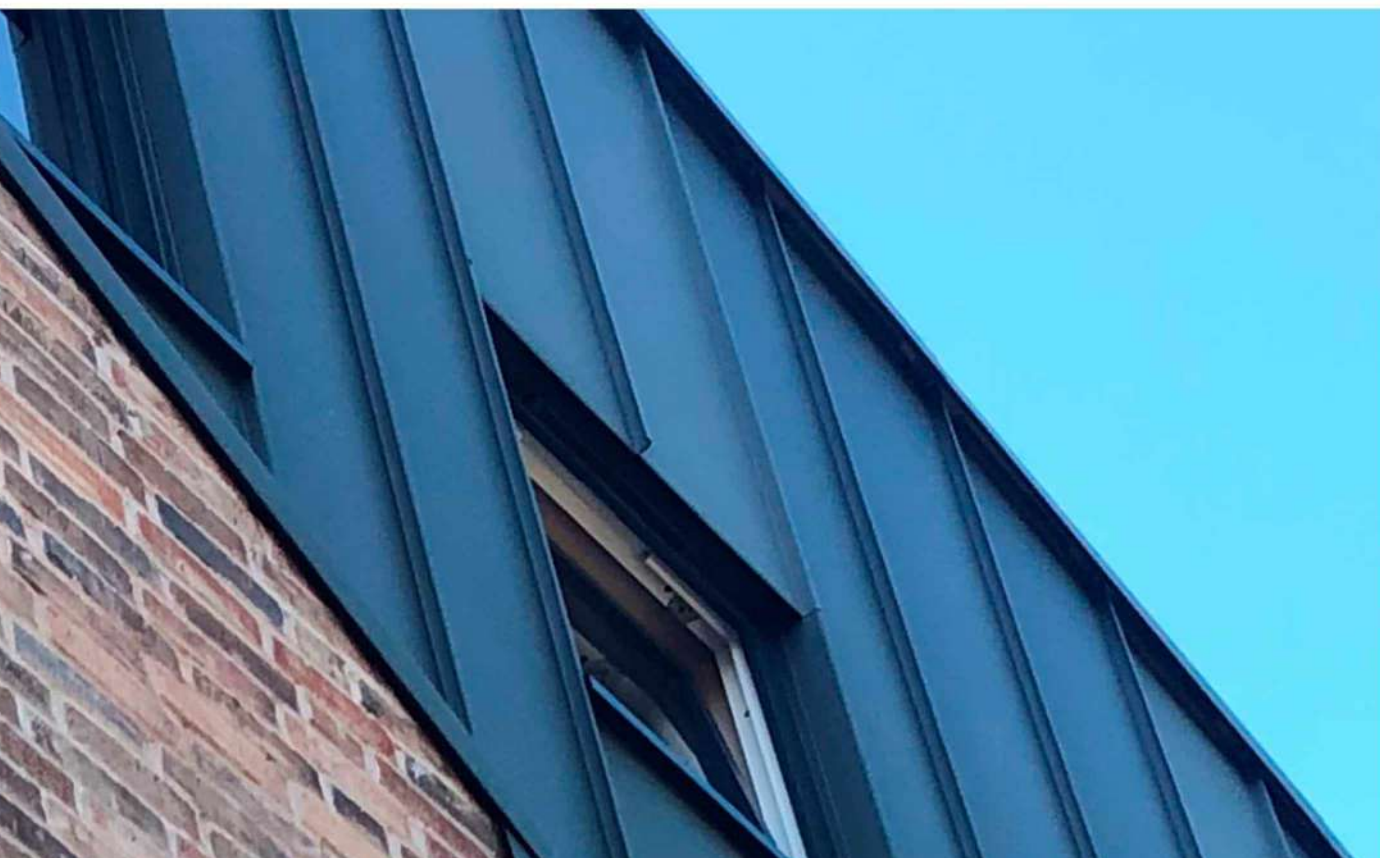

elZinc Lava®

Product description:

elZinc Lava® is a charcoal grey pre-weathered zinc. Its colour sits perfectly amongst the other finishes in the elZinc range and thus allows a greyscale gradient design that can add dynamism to façades in a strikingly unique way.

The pre-weathered finish is created using a surface treatment that maintains intact the zinc's original properties.

Resistant and good looking, it can be incorporated into both contemporary and traditional architecture.

Private house, Chaves, Portugal.



elZinc Rainbow®

Product description:

elZinc Rainbow® is available in a range of natural, warm and attractive graded colours.

It is rolled titanium zinc which complies with the European standard UNE-EN 988. elZinc Rainbow® is achieved by applying mineral pigments to our pre-treated zinc. The 35µm organic coating is a very attractive and durable finish that provides additional protection against corrosion.

Its subtle, versatile shades are suitable for all types of architecture, opening up exciting opportunities for designers. The shimmering, iridescent effects of elZinc Rainbow® combine modernity and tradition, to be enjoyed by all.

Like all elZinc® products, the elZinc Rainbow® range ensures high quality, lasting results.

elZinc® has developed a process which allows it to offer custom colours*. Don't hesitate to ask about personalized finishes - contact us!

*Conditions apply.

elZinc Rainbow® range

elZinc Rainbow® Red



elZinc Rainbow® Blue



elZinc Rainbow® Green



elZinc Rainbow® Brown



elZinc Rainbow® Ebony



elZinc Rainbow® Gold



Adelaide Convention Centre, Adelaide, Australia.
Woods Bagot.



UEA Blackdale Student Residence development,
Norwich, England - LSI Architects.
(Images supplied courtesy of SIG Zinc & Copper)



elZinc Advance®

Product description:

elZinc Advance® provides additional protection for **elZinc Slate®** and **elZinc Graphite®** roofs and façades situated in locations with especially corrosive atmospheres (for example located near to the sea) and that also have areas of cladding that are not frequently washed by rainwater.

The **elZinc Advance®** technology is available for **elZinc Slate®**, **elZinc Graphite®**, **elZinc Lava®**, **elZinc Crystal®** and **elZinc Oliva®** finishes.

elZinc Advance® is rolled architectural titanium-zinc manufactured according to the requirements established by EN988, which is then coated on its outside face with an organic layer.

- **Barrier effect:** It is impermeable to corrosive atmospheric elements.

- **Inhibitor:** It minimizes adhesion of salt and inorganic substances which may cause white oxidation in coastal areas.

elZinc® recommends its application for projects that have areas of cladding protected from the washing effect of rain in:

- Highly polluted areas
- Coastal areas
- Other aggressive climates (check with our Technical Department)

Penguin Parade Visitor Centre, Phillip Island, Australia.
Terroir



Bournemouth development, London, England.
Broadway Malyan.



eZinc Protect+®

Product description:

eZinc Protect+® is a rolled zinc-titanium alloy produced according to the European Standards EN1179 and EN988 and American Standard ASTM B-69, which is then coated on its backside surface by a protective layer of 60 microns.

This protective white layer allows the zinc to be installed over otherwise incompatible substrates, avoiding its corrosion.

The **eZinc Protect+®** technology is available for all the aesthetic finishes manufactured by eZinc.

Main applications:

- Installation on incompatible substrates.
- Installation on roofs which require a greater level of protection against underside corrosion of the zinc.

Curtin University Research Facility, WA, Australia.
Silver Thomas Hanley Architects.





Delivery Program for standard coils and sheets

Table 2

		elZinc Alkimi® (elZinc Natural®, elZinc Slate®, elZinc Graphite®, elZinc Lava®, elZinc Crystal® and elZinc Oliva®)							
		Coils (> 1000 kg) 1 / pallet		Small coils 6 / pallet		Sheets (1000 kg pallet*)			
						2000 x 1000 mm		3000 x 1000 mm	
Thickness mm	Width mm	Approx. length m.l.	Theoretical weight kg	Approx. Length m.l.	Theoretical weight kg	Weight*/ sheet kg	Sheets / pallet	Weight*/ sheet kg	Sheets / pallet
0,7	500	397	1000	40	100				
	600	331	1000	34	100				
	670	296	1000	30	101				
	1000	198	1000	20	101	10,08	102	15,12	66
0,8	500	347	1000	35	101				
	600	289	1000	29	100				
	670	259	1000	26	100				
	1000	174	1000	17	98	11,52	89	17,28	58
1	500	277	1000	28	101				
	600	231	1000	23	99				
	670	207	1000	21	101				
	1000	138	1000	14	101	14,4	69	21,6	46

*theoretical weights

elZinc Slate®, elZinc Graphite®, elZinc Lava®, elZinc Crystal®, elZinc Oliva® sheets and coils are delivered with a protective film.

Other sizes and thicknesses are available upon request.

Coil inside dimension: coils ≥ 1T = 508mm - Small coils = 300mm

In general, we recommend that the film is removed when installation of the job is complete, just before hand-over of the zinc work. However, if further protection is required it can be left on up to the following limits:

- Sunlit areas – maximum of 3 months
- Partial shade – maximum of 4,5 months
- Shaded areas – maximum of 6 months.



Table 3

		elZinc Rainbow®, elZinc Advance® and elZinc Protect+®							
		Coils (> 1000 kg) 1 / pallet		Small coils 6 / palet		sheets 200kg pallet *		sheets 500kg pallet *	
						2000 x 1000 mm		2000 x 1000 mm	
Thickness mm	width mm	Approx. Length m.l.	Theoretical weight kg	Approx. Length m.l.	Theoretical weight kg	Weight*/ sheet kg	Sheets / pallet	Weight*/ sheet kg	Sheets / pallet
0,7	500	397	1000	40	100				
	600	331	1000	34	100				
	650	305	1000	31	101				
	670	296	1000	30	101				
	1000	198	1000	20	101	10,08	20	10,08	50
0,8	500	347	1000	35	101				
	600	289	1000	29	100				
	650	267	1000	26	98				
	670	259	1000	26	100				
	1000	174	1000	17	98	11,52	17	11,52	43
1	500	277	1000	28	101				
	600	231	1000	23	99				
	650	214	1000	21	98				
	670	207	1000	21	101				
	1000	138	1000	14	101	14,4	14	14,4	35

*theoretical weights

elZinc Rainbow®, elZinc Advance® and elZinc Protect+®

sheets and coils are delivered with a protective film.

Other sizes and thicknesses are available upon request.

Coil inside dimension : coils ≥ 1 T = 508mm - Small coils = 300mm

In general, we recommend that the film is removed when installation of the job is complete, just before hand-over of the zinc work. However, if further protection is required it can be left on up to the following limits:

- Sunlit areas – maximum of 3 months
- Partial shade – maximum of 4,5 months
- Shaded areas – maximum of 6 months.



elZinc® Tiles

Product description:

Whether for new-build or refurbishment projects, prefabricated **elZinc®** tiles are a great solution for wall cladding and for weathering roofs pitched over either 25° or 45° (depending on the type of tile used).

Our five types of shingles, made of **elZinc®** zinc-titanium (EN988 standard), lend themselves to all architectural styles, in perfect harmony with the surrounding materials.

elZinc Slate, elZinc Graphite and elZinc natural are available in 0,65mm and 0,7mm. The rest of elZinc finishes are only available in 0,7mm.

In addition to their ecological and aesthetic qualities, elZinc® tiles are:

- Easy to install
- Suitable for most projects
- Highly corrosion resistant
- Virtually maintenance free

Square tile:

elZinc®'s square tile with polystyrene reinforcement is notable for its ease of installation. Its clean design gives the cladding an elegantly neat appearance.

- **Elements number/m²:** 9.
- **Approx. weight/m² (in 0,7 mm):** 7,3 kg
- **Dimensions:** 400 x 400 mm (parallel edges)
512 x 555 mm (height x width)
- **Tiles/box:** 24



Rhomboid tile:

The elZinc® rhomboid tile gives a stylised look to roofs and façades. The sleek interlocking tile highlights verticality, and is suited to both modern and traditional architecture.

- **Elements number/m²:** 14
- **Approx. weight/m² (in 0,7 mm):** 7,8 kg
- **Dimensions:** 260 x 260 mm (parallel edges)
560 x 280 mm (height x width)
- **Tiles/box:** 35



elZinc® Tiles

Pointed fish scale tile:

This **elZinc®** tile brings to mind images of baroque architecture. It provides, in its simplicity, a discreet, traditional feel to the building.

- **Elements number/m²:** 72
- **Approx. weight/m² (in 0,7 mm):** 10,9 kg
- **Dimensions:** 240 x 142 mm
- **Tiles/box:** 144



Rounded fish scale tile:

A new twist on a classic model. **elZinc®**'s rounded fish scale tile is inspired by a shape commonly used in traditional European architecture.

- **Elements number/m²:** 41
- **Approx. weight/m² (in 0,7 mm):** 7,4 kg
- **Dimensions:** 280 x 200 mm
- **Tiles/box:** 104



Diamond tile:

The diamond tile elZinc offers the architect a modern and attractive option. A larger format tile suitable for a wide range of applications.

- **Elements number/m²:** 9,12
- **Approx. weight/m² (in 0,7 mm):** 7,2 kg
- **Dimensions:** 340mm (perpendicular to hemmed edges)
611 x 415 mm (height x width)
- **Tiles/box:** 20



elZinc®'s range of tiles are available in every elZinc® aesthetic surface finish

elZinc® Natural



elZinc Slate®



elZinc Rainbow® Blue



elZinc Rainbow® Black



elZinc Graphite®



elZinc Crystal®



elZinc Rainbow® Red



elZinc Rainbow® Green



elZinc Oliva®



elZinc Lava®



elZinc Rainbow® Brown



elZinc Rainbow® Gold



elZinc® Honeycomb panel

An ideal architectural solution for wall cladding:

The **elZinc® honeycomb panel**, manufactured in a continuous production process, is a new generation material and represents the perfect integration of technology, safety, durability and natural beauty.

elZinc® A2 fire-rated panels are formed by two **elZinc®** skins bonded to both faces of an aluminium honeycomb core, making an extremely light, yet exceedingly flat and ridged architectural cladding material.

The ample range of combinations and colours available enables the use of **elZinc®** to create innovative designs both in new-build and in refurbishment projects.

A bespoke supporting system – HideTech® PLUS -, the world's first perimeter point-fixing system for architectural panels, takes advantage of the excellent rigidity of elZinc® panels.

Very easy to install, it also allows:

- Cost and weight reduction.
- Easy panel replacement (no need to dismount surrounding panels)
- Vertical and horizontal installation orientation
- Free but controlled thermal expansion and contraction
- Wall brackets that are fully adjustable in three directions
- Total security

System basic information

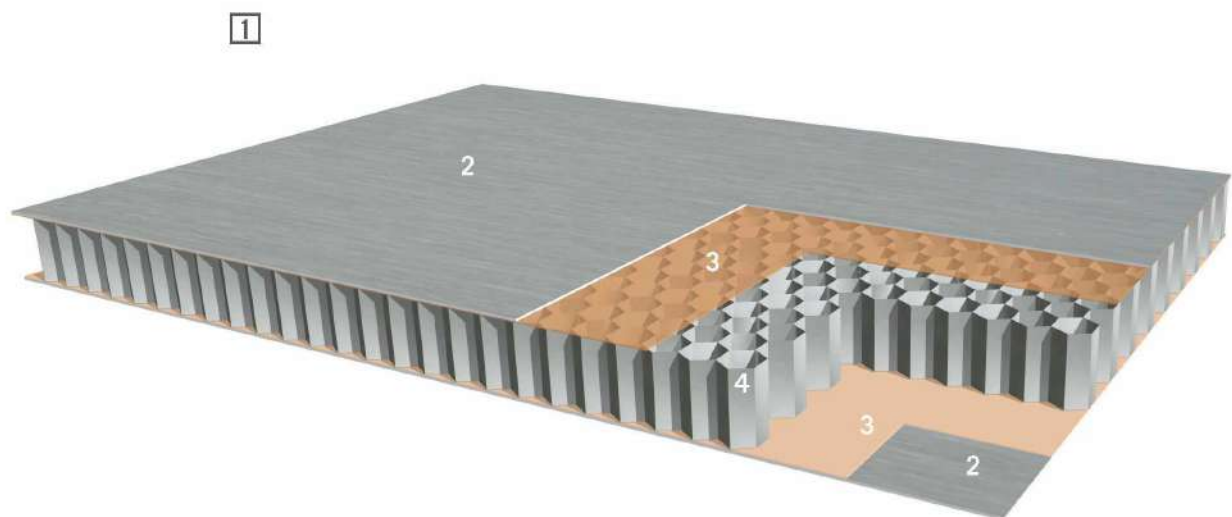

1. elZinc® honeycomb material
2. 0.5mm elZinc® panel skin
3. Adhesive
4. 14mm aluminium honeycomb core

Main features:

- Minimum/maximum length: 2.000 / 8.000 mm
- Standard width: 1.000 mm
- Total thickness: 15 mm
- Internal skin thickness: 0,5 mm
- External skin thickness: 0,5 mm
- Panel weight: 8,6 kg/m²



European Technical Assessment:
ETA 16/0415 of 23/05/2016

Available in every el Zinc® aesthetic surface finish and in elZinc Advance®:

elZinc® Natural



elZinc Slate®



elZinc Crystal®



elZinc Lava®



elZinc Oliva®



elZinc Graphite®

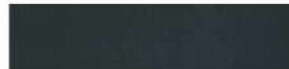

elZinc Rainbow® Red



elZinc Rainbow® Green



elZinc Rainbow® Blue



elZinc Rainbow® Black



elZinc Rainbow® Brown



elZinc Rainbow® Gold



elZinc® Composite panel

Main applications:

elZinc® composite material is a high quality wall cladding material, providing long-term performance and flexibility of design for the most demanding of projects.

It consists of two elZinc® sheets continuously bonded to a ridged core made of either low-density polyethylene (PE) or of mineral filled Fire Resistant resin (FR) to provide flatness and lightness. The FR core material is defined as providing very little contribution to a fire by Euroclass fire classification.

The advanced production process ensures excellent bonding, achieving twice the recommended delamination values.

elZinc® composite panel will enhance your most creative project with its range of finishes (elZinc Alkimi® and elZinc Rainbow®).

Basic system information

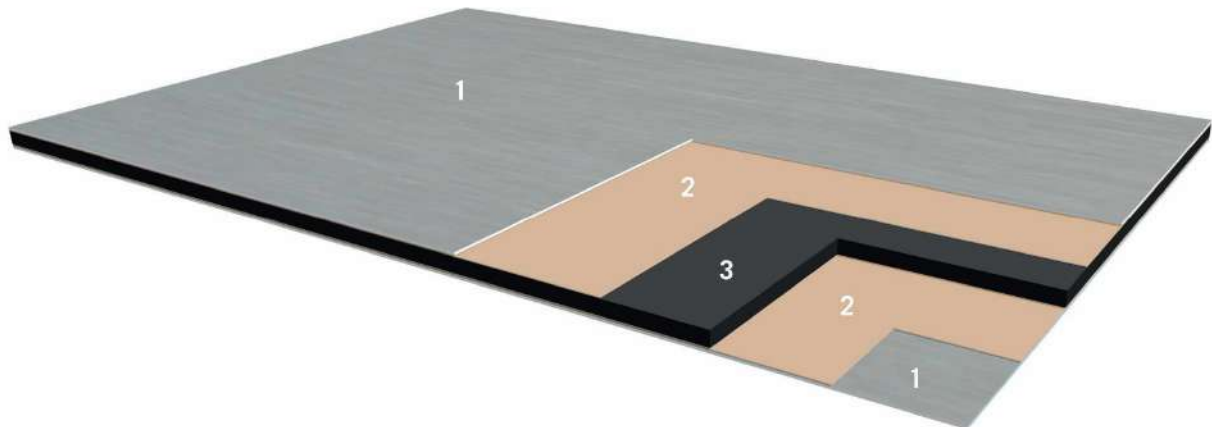

1. elZinc® skin
2. Adhesive
3. FR or PE core

Product characteristics:

elZinc® PE composite panel

- **Length:** up to 8.000 mm
- **Standard width:** 1.000 mm
- **Total thickness:** 4 mm
- **Internal skin thickness:** 0,5 mm
- **External skin thickness:** 0,5 mm
- **Weight:** 10,06 kg/m²

Reaction to fire test : M1 acc. to UNE23727:1990

elZinc® FR composite panel

- **Length:** up to 8.000 mm
- **Standard width:** 1.000 mm
- **Total thickness:** 4 mm
- **Internal skin thickness:** 0,5 mm
- **External skin thickness:** 0,5 mm
- **Weight:** 12,2 kg/m²

Reaction to fire test: B-s1, d0



Available in every elZinc® aesthetic surface finish and in elZinc Advance®:

elZinc® Natural



elZinc Slate®



elZinc Crystal®



elZinc Lava®



elZinc Oliva®



elZinc Graphite®

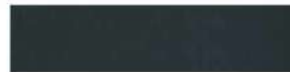

elZinc Rainbow® Red



elZinc Rainbow® Green



elZinc Rainbow® Blue



elZinc Rainbow® Black



elZinc Rainbow® Brown



elZinc Rainbow® Gold



4. Systems





School canteen, Hamburg, Germany - Reichardt Architects



Traditional systems

Traditional systems are fully supported metal coverings that employ tried and tested hard metal seaming and fixing techniques which have been used for centuries.

The most noteworthy are:

- **Double lock standing seam**
- **Angle standing seam**
- **Flat lock shingles**
- **elZinc® tiles**

Party Hall, Berstett, France.
Larche & Metzger.



Botanical Garden, South Korea.



Traditional systems

The complete **elZinc®** range of finishes can be installed using these systems. They have several characteristics in common:

Light, timeless, artisan appearance:

These systems are installed by specialist hard metal roofing contractors giving a hand crafted, made-to-measure feel. The subtle quilting that can become apparent naturally under different light conditions introduces a bit of visual 'vibration' and 'energy' to the building.

Adaptable and architecturally flexible:

Making use of the malleability of **elZinc®**, the panels can be curved, tapered, formed and folded to conform to almost any geometric design. Intelligent use of the joints can convey interesting effects.

Proven durability:

Zinc standing seam roofs have been known to last for well over half a century, and traditional zinc cladding lasts even longer.

Economical:

The thin gauge of **elZinc®** used (0.65 to 0.8mm – only 5,6 to 7 kgs/m²) coupled with modern bending and profiling technology keeps costs more affordable than most architects appreciate.

Installation:

They should be installed by experienced fully supported metal roofing specialists. Contact **elZinc®** for a list of reputable firms for your project.

Hallym University, Korea



Technically, they share the following features:

Use of thin gauge zinc:

Zinc between 0.65 and 0.8 mm is normally used since these systems require ease of hand forming on site to execute the joints and details. In countries new to this type of cladding, there is a temptation on occasion to use heavier gauge material to eliminate oil canning, but this should only be done after consultation – many traditional joint details cannot be executed in material thicker than 0,8 mm.

Folded and welted joints to connect panels:

These joints create protruding seams or small steps between the panels. They are either simply interconnected or welted together on site. The seams are not watertight, and their weathertightness varies, so each type of joint has its own pitch-related limits. Optically, these joints interact with the light generating interesting effects which can influence our perception of the façade at different times of the day and year.

Fully supporting substrate:

Due to the thin gauge of the zinc used, they require a fully supporting substrate (or partially supporting substrate for façades). This can either be of a vented or unventilated design, and helps reduce rain drumming especially if combined with structural underlays.

Indirect fixing using stainless steel clips:

These fixings are hidden by being overlapped by the next panel in the sequential installation of the covering. They hold the cladding down to the substrate whilst ensuring it can expand and contract freely as it warms up or cools down.

Governed by national norms and codes of practice:

These systems should be installed according to national standards and codes of practice. Independent system certification should not be required since they employ tried and tested techniques and methods.

Office building, France - Jean-Paul Faure.



Traditional systems

Panel widths and clip centers in traditional systems

The standing seam, angle seam and flat lock panel systems all use the same set of seam centers, which are tied into commercially available coil widths.

Therefore, the following table can be used to determine the bay widths, thicknesses, and also to specify the number of fixings per m² for each of these systems.

Table 2

System dimensioning		FIXING REQUIREMENTS – NUMBER OF CLIPS PER M ² / CLIP CENTRES IN CMS RELATED TO BUILDING HEIGHT (H)								
		<8m			8m<H≤20m			20<H≤100m		
Thickness	Bay width	Center	Edge	Corner	Center	Edge	Corner	Center	Edge	Corner
0,7	430	3,9 / 48	3,9 / 48	6,4 / 29	3,9 / 48	5,5 / 34	9,6 / 20	3,9 / 48	7,7 / 25	12,8 / 15
0,7	530	3,9 / 48	3,9 / 48	6,4 / 29	3,9 / 48	5,5 / 34	9,6 / 20	3,9 / 48	7,7 / 25	12,8 / 15
0,7	600	3,9 / 43	3,9 / 43	6,4 / 26	3,9 / 43	5,5 / 30	9,6 / 17	3,9 / 43	8,5 / 20	12,8 / 13
0,7	630	4 / 40	4 / 40	6,4 / 25	4 / 40	5,4 / 29	10 / 16			

Notes: Assumes a nominal clip pull out load of 560N. Valid for non-exposed locations.

Various factors affect wind uplift - (location, exposure, orientation and roof geometry) and advice should be sought from eZinc® when determining tray widths for projects in exposed locations.

This is not only to ensure that the cladding does not suffer during storms, it is also to avoid fluttering of the trays during periods of continuously windy weather.

Bay widths may be narrowed to the next standard width in order to reduce quilting in the sheets if a flatter appearance to the cladding is required, especially for wall cladding or steeply pitched roofs.



Double lock standing seam

Key points

- **Proven, versatile system** for roofing flat, curved and 'free-form' roofs.
- **Weather-tight down** to 7° of pitch, 3° if seams are sealed.
- **Discrete joints** give a light, elegant appearance.
- **Modern profiling and seaming machines** facilitate short installation times.
- **On-the-roof detailing** uses folding techniques or soldered joints – no mastic!
- **Items** such as snow guards and life line attachments are readily available.

Basic system information

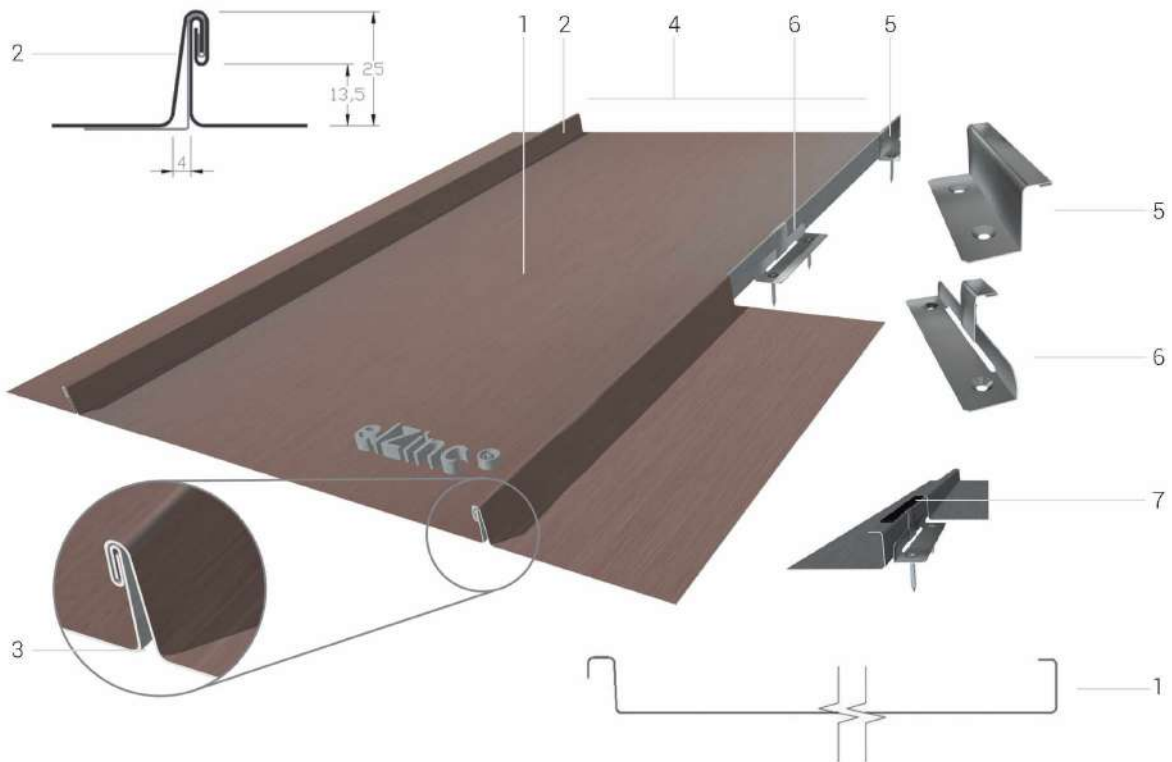

1. elZinc® Standing seam roofing tray, nominal max. length 10m
2. Standing seam joint (normally follow line of maximum pitch)
3. Expansion gap at seam base
4. Seam centres dimension. Normally from 430 to 600mm

5. Stainless steel 'fixed' clip – anchors the tray in position
6. Stainless steel 'sliding' clip - allows longitudinal expansion
7. Self-expanding sealing strip for roofs pitched under 7°

The joint

The joint requires 70mm of material to make. It is formed by seaming together profiled trays of zinc as illustrated on the right.



Seaming process

1

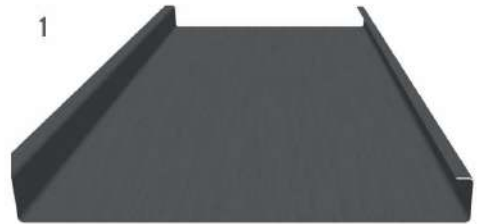

Standing seam tray

2

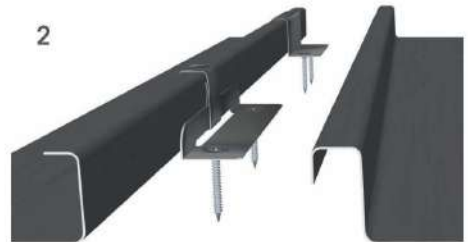

Clipped undercloak and the overcloak

3



Small gap at base forms automatically and allows for lateral thermal expansion

4



First turn completes angle standing seam joint

5

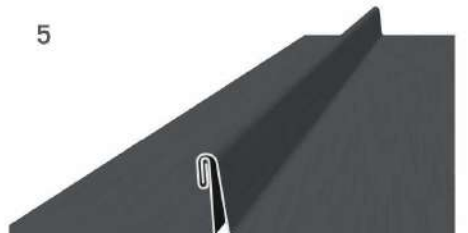

Double lock welt, second turn completes double lock standing seam joint

Double lock standing seam

Cross joints

Transverse joints vary according to roof pitch. They are needed to introduce expansion joints on large roofs or around details.

Cross joints

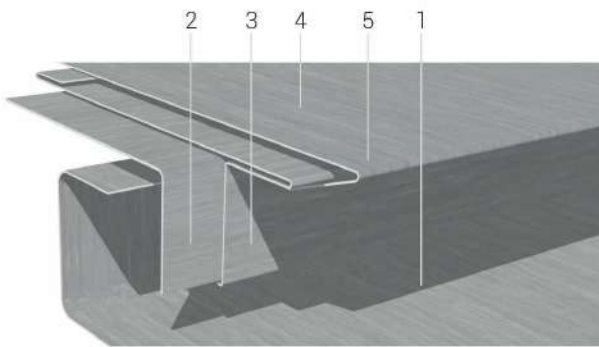

Step

Pitch: 3° and above

Height: 60mm

Often used as an expansion joint on long, low pitched roofs. The step in the substrate can be formed using a fillet.

1. Lower roofing tray
2. Continuous fixing strip
3. 'T' plate with folded back edge
4. Upper roofing tray
5. Expansion/contraction gap

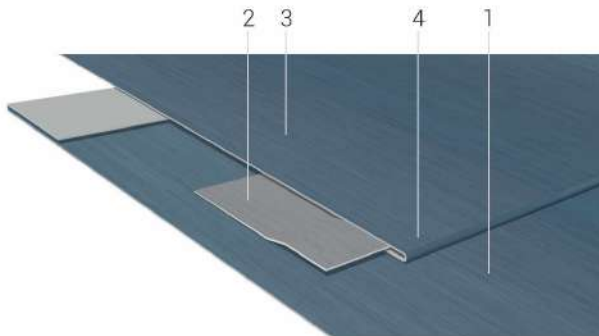

Lap lock

Pitch: 10° and above

Lap: Approx. 180mm

Often used as an expansion joint on long roofs.

1. Lower roofing tray
2. Soldered continuous cleat
3. Upper tray
4. Expansion/contraction gap

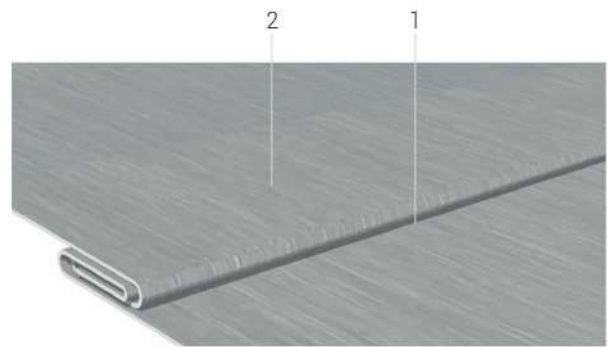

Double lock cross welt

Pitch: 7° and above

Width: Approx. 20mm

The preformed 'slide in' type (shown here) allows for perfect rainwater drainage.

Does not function as an expansion joint.

1. Lower roofing tray
2. Upper tray

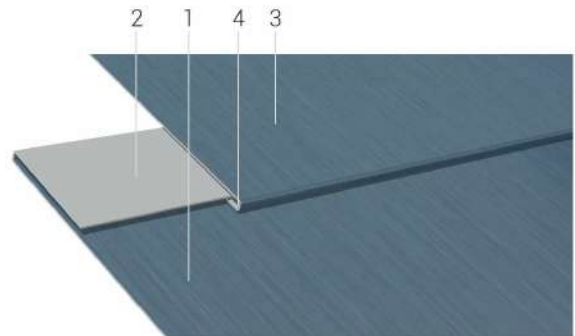

Single lock cross welt

Pitch: 25° and above

Width: 40mm fold on lower tray, 30mm on upper tray. Can be used as an expansion joint on long roofs.

1. Lower roofing tray
2. 40mm fold
3. Upper tray
4. Expansion/contraction gap

Dimensioning and fixing

The width of the trays should be dimensioned using the information in table 2, page 38. If the length of the roofing trays is over 1,5m the clips used to secure them to the substrate must allow the zinc to expand and contract, and these trays use a combination of fixed clips and sliding clips to accomplish this.

The position of the fixed clip zone depends on roof pitch – to avoid the trays from buckling when expanding up the roof from the fixed zone, the steeper the pitch, the higher the anchoring band of fixed clips is positioned. The thermal movement generated in the trays is accommodated by a gap introduced in the detail at the foot and at the head of the trays.

Installation

The system is installed across the roof in either direction, or preferably outwards from a centrally placed undercloak – undercloak tray that ensures trays of equal width (and therefore symmetry) at both ends of the roof.

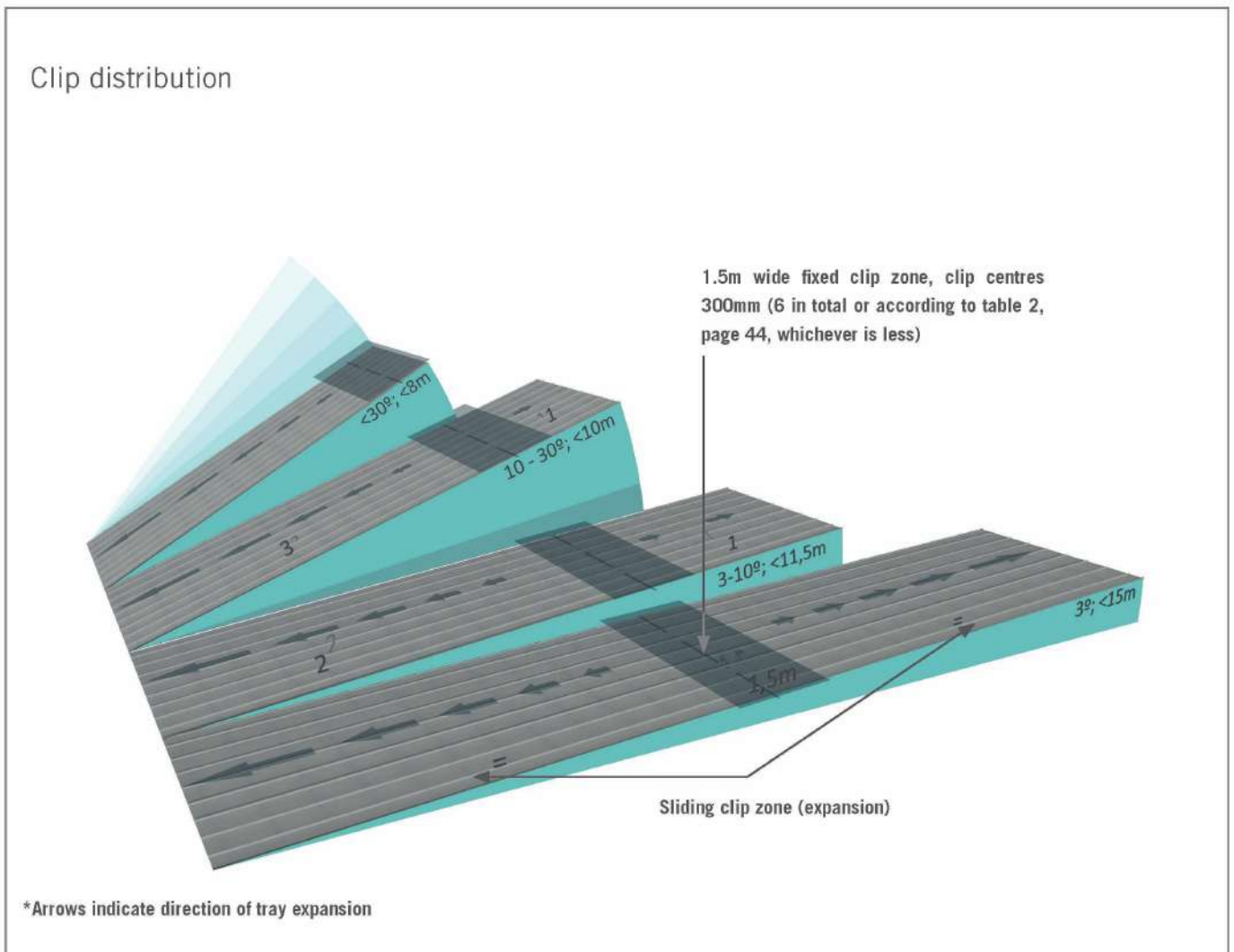

Double lock standing seam

Examples of typical details

Below are some examples of typical details. These and others, are available from our website. **elZinc®** also develops project specific details if required. For more detailed information on this system, please download the System Drawings pdf available from our website.

Details

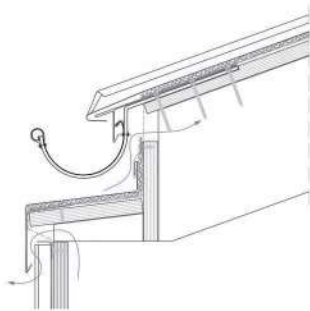

Eaves – Half-round gutter over zinc apron

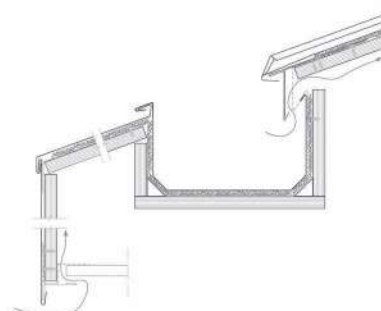

Eaves – Hidden boxed-gutter over zinc fascia

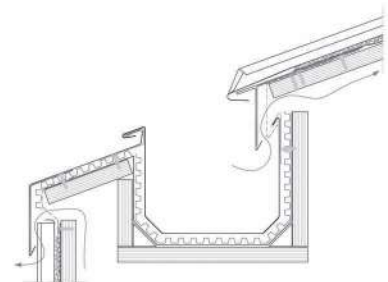

Eaves - Hidden-boxed eaves gutter over angle seam cladding

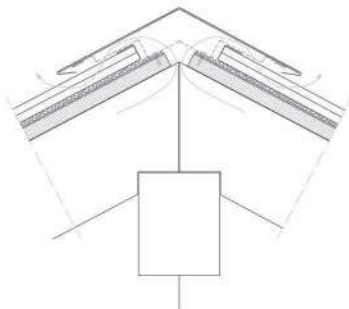

Flat vented ridge

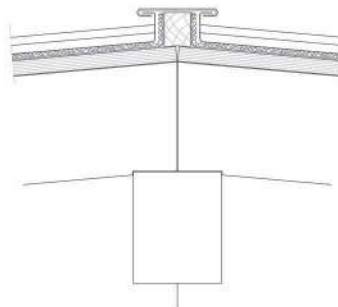

Unvented square batten ridge

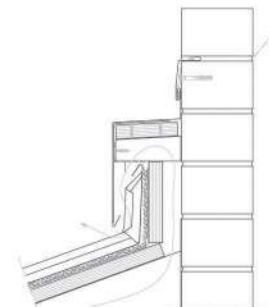

Vented abutment to brick wall

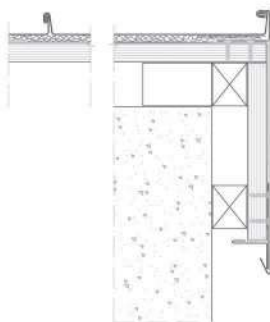

Standing seam Verge - deep



Vented transition mansard roof

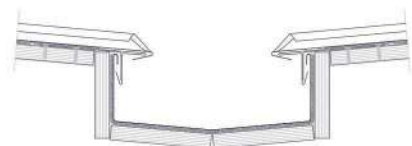

Boxed valley gutter



Angle standing seam

Key points

- **Traditional cladding system** based on the double lock standing seam
- **Principally used** in façade cladding, on flat or curved areas
- **Weather-tight** from 25° of pitch and above if used in roofing. 35° in regions with heavy snowfall
- **Attractive design layouts** complement different architectural styles
- **Suitable** for ventilated façade designs
- **Can use semi continuous substrate**

Basic system information

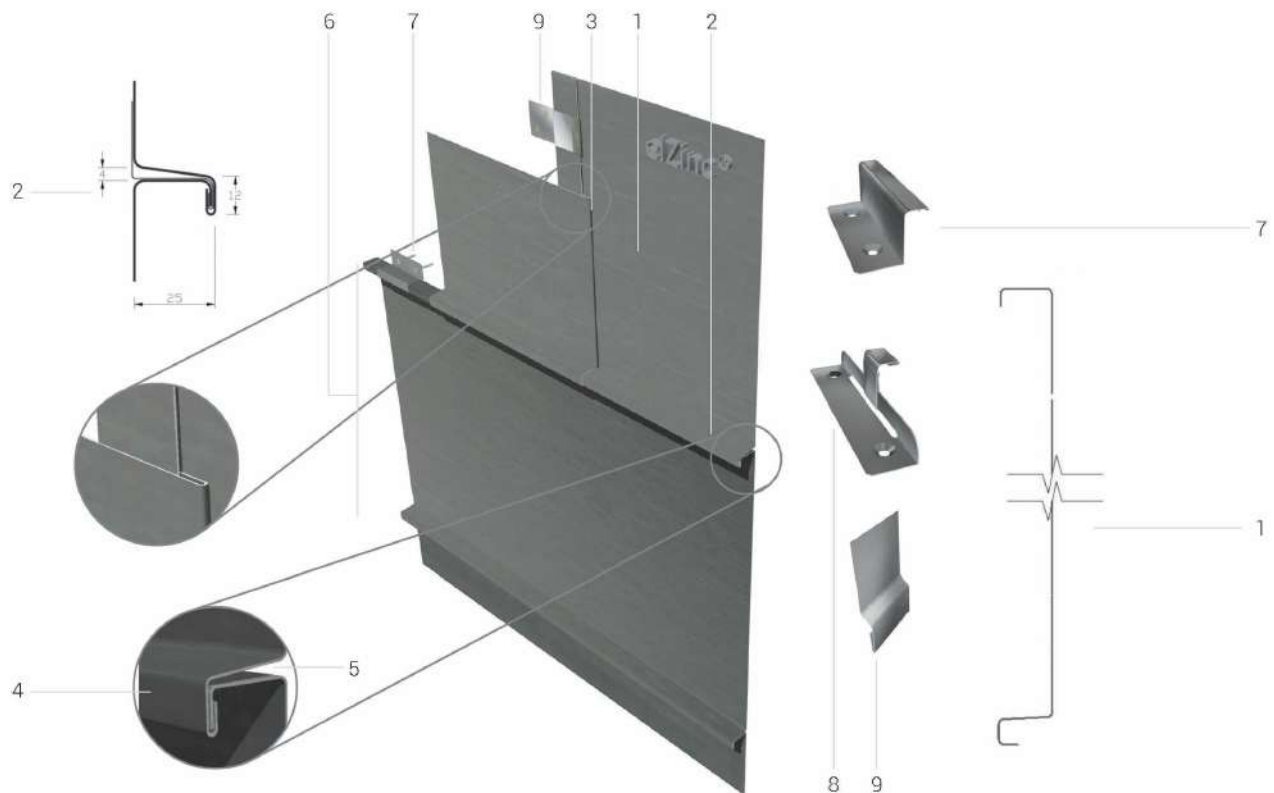

1. eZinc® angle standing seam roofing tray.
2. Angle Standing seam joint (horizontal, vertical or set at an angle).
3. Flat lock transversal joint.

4. Welt of angle seam.
5. Expansion gap at seam base.
6. Seam centres dimension, normally from 430 to 600mm.

7. Stainless steel 'fixed' clip – anchors the tray in position.
8. Stainless steel 'sliding' clip
9. Stainless steel flat lock clip

Appearance

Angle seam façades exhibit fairly pronounced directionality – the longitudinal angle seam is more visible than the flat lock cross joints and so it dominates the aesthetic. The thin gauge zinc used can produce some degree of oil canning adding character to the façade. If desired, this can be minimised by using 0.8 mm **elZinc®** in narrower panel widths of 430 mm.

Fixing and dimensioning

The width of the trays should be dimensioned using the information in table 2, page 38.

Aesthetic considerations sometimes mean narrower trays than those required to resist wind loading are chosen.

Art du Toit, Quebriac, France – Quinze Architecture.



Angle standing seam

Design possibilities

The angle seam system offers the architect the opportunity to get creative with seam centers and cross joint placement to complement or enhance certain aspects of the overall design of the project.

A few of the more common designs are shown here. The horizontal designs can also be used vertically. Long strip horizontal cladding is not recommended due to site handling difficulties.

Examples

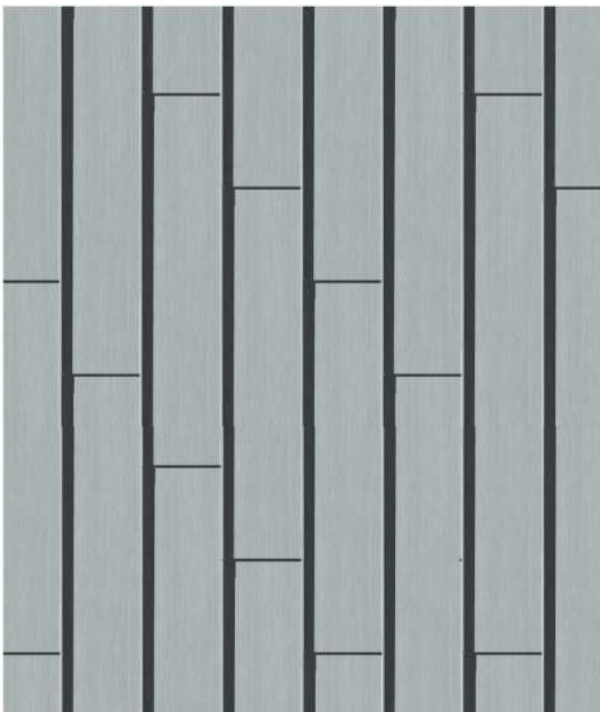

Long strip vertical or near vertical

Not recommended for horizontal formats due to site handling issues.

Seam centres: 430, 530, 580 and 600mm

Panel length: Maximum of 10000mm recommended

Effect: Clean and elegant



The cross joints can be set at an angle if desired to create other visual effects. No extra material is needed.



Staggered

Seam centres: 430, 530, 580, and 600mm

Panel length: Maximum of 3000mm recommended.

Effect: The cross joints will create some verticality as they line up



Stepped

Seam centres: 430, 530, 580, and 600mm

Panel length: Maximum of 3000mm recommended

Effect: The stepped cross joints impart a sense of movement

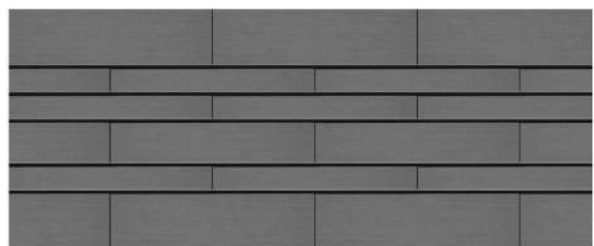

Varying panel widths

Seam centres: 263, 430, 600mm shown

Panel length: Maximum of 3000mm recommended

Effect: Very longitudinal and very distinctive. Gives the façade a very individual feeling

Examples of typical details

Below are some examples of typical details of horizontal cladding. These and others, as well as their equivalents for vertical cladding, are available from our website.

elZinc® also develops project specific details if required. For more detailed information on this system, please download the System Drawings pdf available from our website.

Details

Ground level foot **Front vented capping** **Rear vented capping**

Continuous seam external corner **Continuous seam internal corner** **Reverse corner abutment**

Vented window sill **Vented window lintel** **Window jamb**

Flat lock shingles

Key points

- **Traditional cladding system** using interlocking panels
- **Principally used** in façade cladding, on flat or curved areas
- **Weather-tight** from 25° of pitch and above if used in roofing
- **Attractive design** layouts complement different architectural styles
- **Suitable** for ventilated façade designs
- **Can use semi continuous substrate**

Basic system information

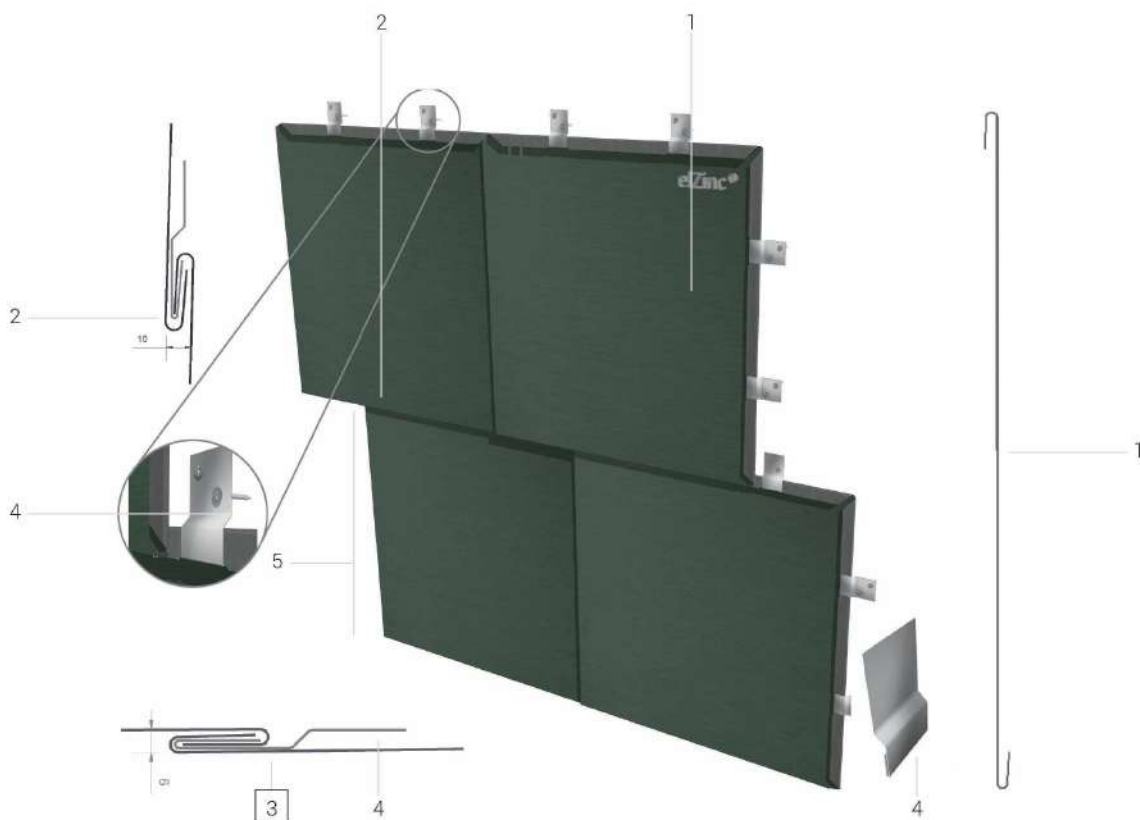

1. elZinc® flat lock shingle tray.

2. Flat lock dominant joint.

3. Flat lock transversal joint.

4. Stainless steel clip (can also be made of the same zinc as the cladding).

5. Seam centres dimension, normally 430 to 600mm.

Appearance

Depending on the layout of the joints, the system can either be directional or not. The seams themselves are very discrete, but they are highlighted by the shadows they cast in sunny weather, making them clearly visible especially on lighter finishes where the contrast is greatest.

This system is not profiled, so oil canning is normally less apparent than with the angle seam system.

Fixing and dimensioning

The width of the shingles should be dimensioned using the information in table 2, page 38.

Each flat lock shingle is indirectly fixed along both out-turned folds (undercloaks) using stainless (or zinc) clips. The number of clips per m² should be according to table 2, page 52.

Camp Southern Ground, Georgia, USA.



Flat lock shingles

Design possibilities

As well as those designs shown for the angle seam for which rectangular shingles are employed, square flat lock shingles are often used but set at 45°. This arrangement can be either fully interlocked or set to leave a small overlap giving a more traditional artisan feel to the cladding.

Other designs are possible of course, as long as the shapes tessellate and the joints shed water correctly. As an example, a rhomboid design is illustrated below. Note how the same façade will change its appearance according to the shadows cast by the flat lock joints at different times of the day.

Examples



Fully interlocked shingles at 45°

Seam centres: 430, 530, 580 and 600 mm

Effect: Visually 'disconnects' cladding from openings and the contours of the façade, so no care need be taken to coordinate opening positions with seam centres.



40mm free edge interlocked shingles at 45°

Seam centres: 430, 530, 580 and 600 mm

Effect: Has a more artisan feel than fully interlocked shingles. Also sets the cladding apart from other elements of the façade (openings, corners etc).

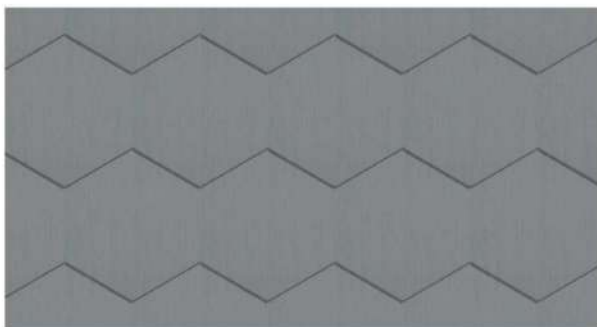

Rhomboid shingles in a vertical design

Seam centres: 430, 530, 580 and 600mm

Effect: Dependent on sun direction. The sun will highlight the cross joints more when full on the façade, when at an angle it will highlight the vertical joints more.



Examples of typical details

Below are some examples of typical details. These and others are available from our website. **elZinc®** also develops project specific details if required.

For more detailed information on this system, please download the System Drawings pdf available from our website.

Details

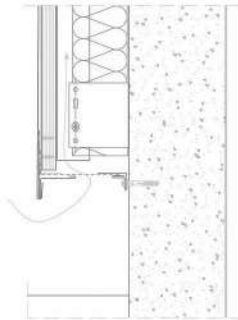

Ground level foot

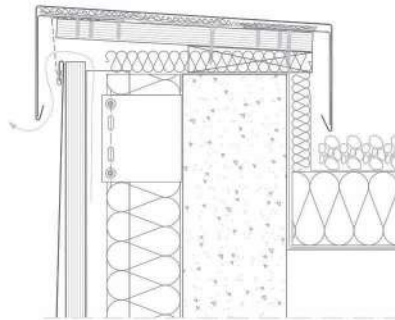

Front vented capping

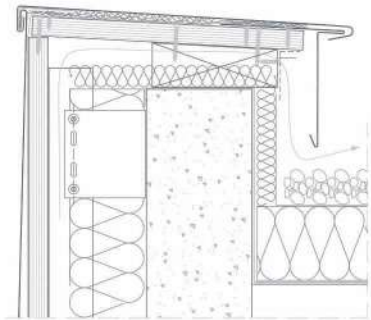

Rear vented capping

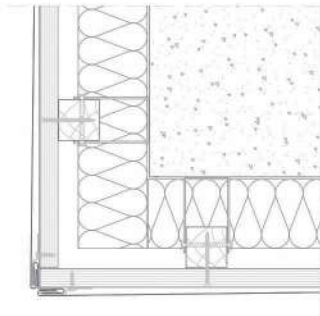

Reverse external corner

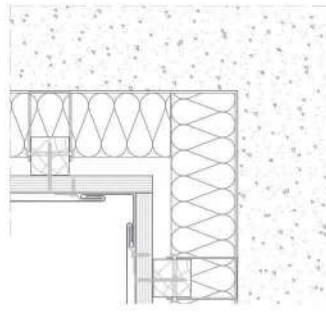

Reverse internal corner

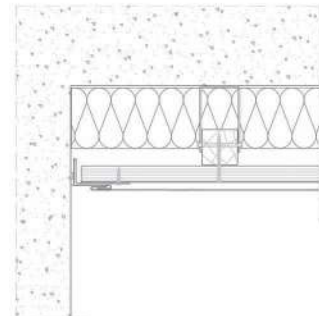

Reverse corner abutment

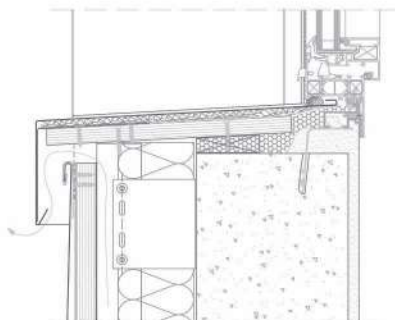

Vented window sill

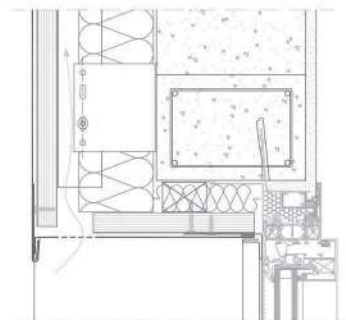

Vented window lintel

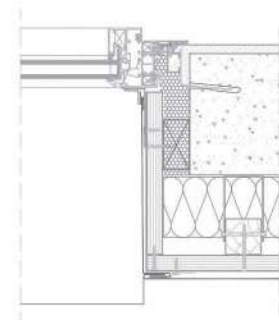

Window jamb

elZinc® Tiles

Key points

- **Pre-fabricated elements** directly fixed to substrate
- **For wall cladding and roofing** (subject to roof pitch)
- **5** different designs
- **Easy to install** – can be cut, edged and folded as required
- **Require fully supporting substrate**
- **Available** in the full range of **elZinc®** finishes

Arzak Restaurant, San Sebastian, Spain.
Estudio LYMA Arquitectura

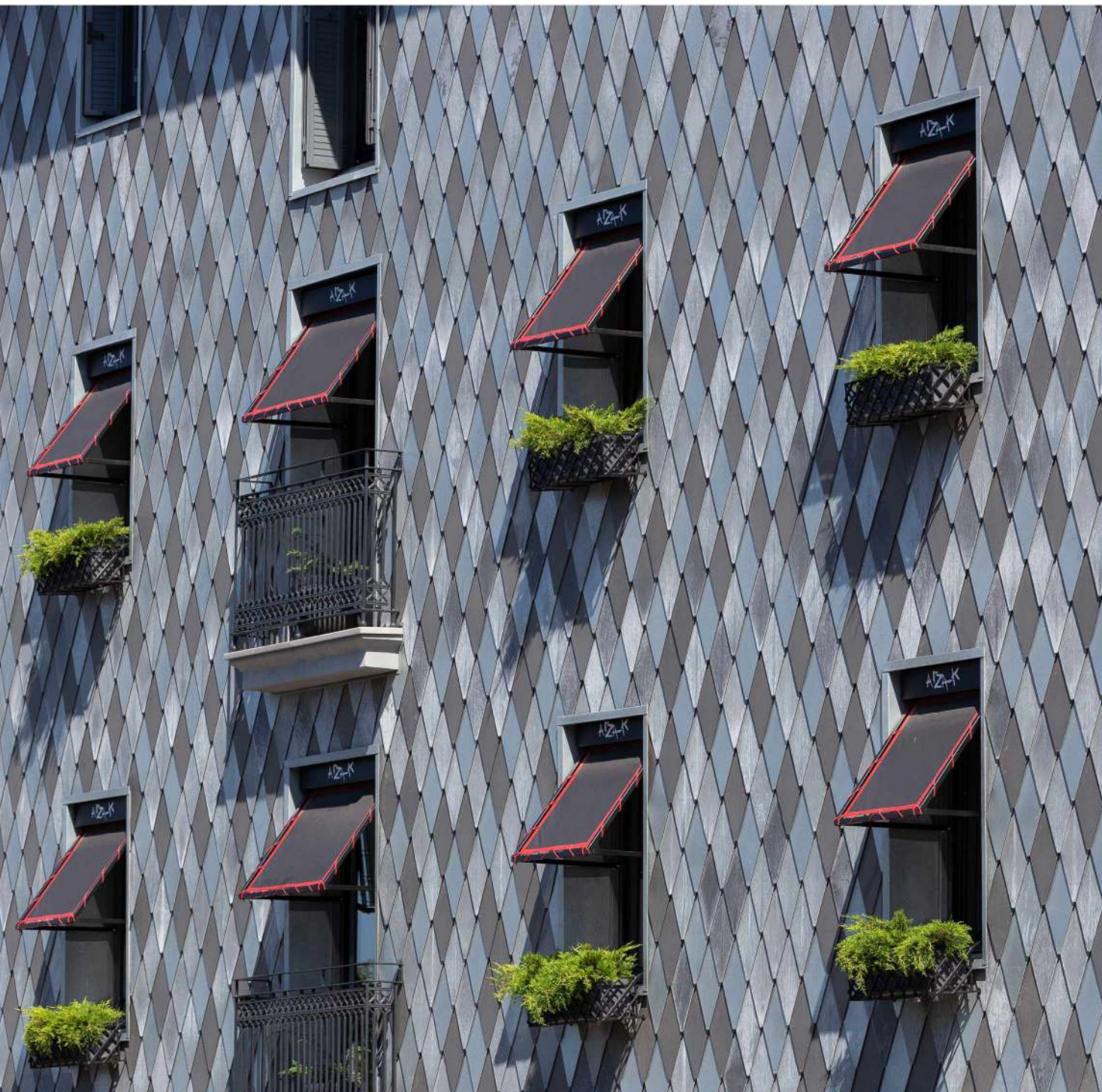

Five different designs

Square tile

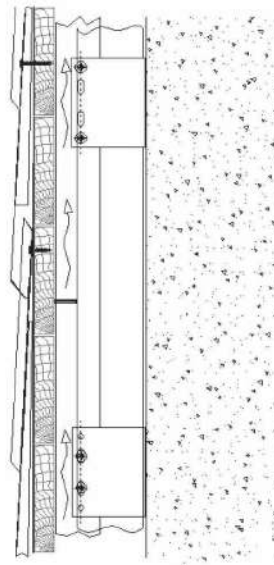
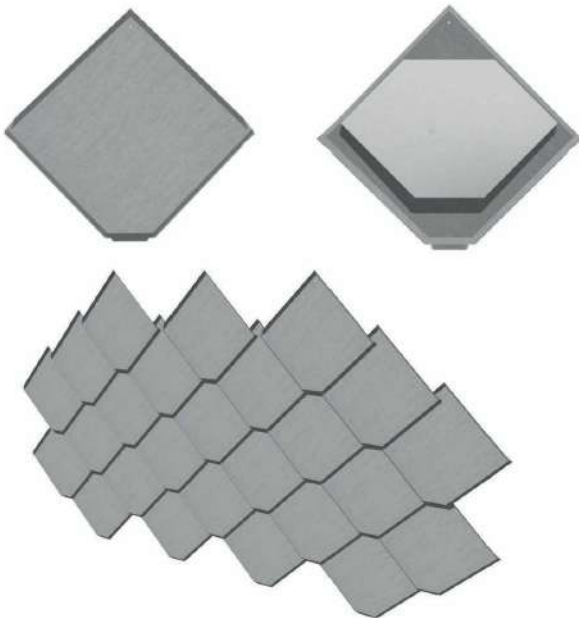

Robust, clean appearance
Rigid backing dampens rain drumming
Good rigidity, flat finish
Weather-tight at 25° and above

eZinc® Rhomboid tile

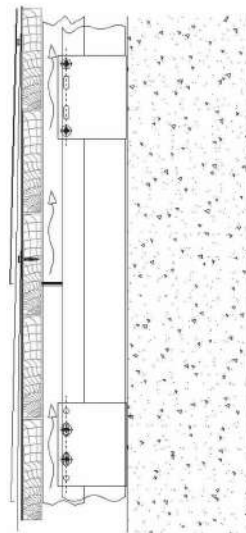
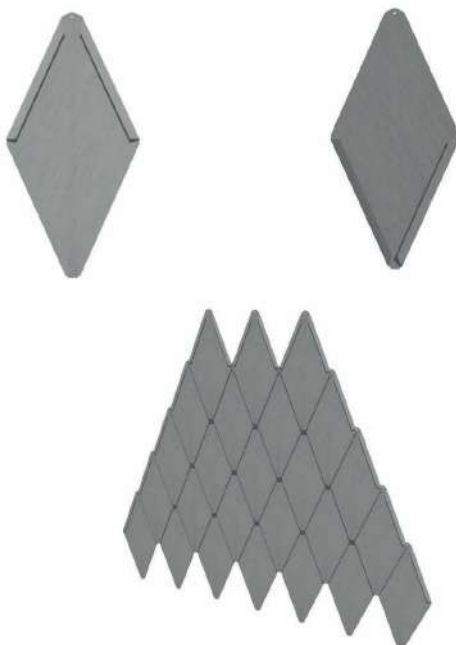

Elegant and artisan aesthetic
Installation on curved surfaces possible
Weather-tight at 25° and above

elZinc® Tiles

Five different designs

elZinc® Fish scale tiles

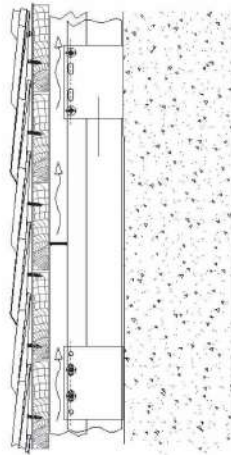

Classic, traditional appearance
Weather-tight at 45° and above
Quick and easy installation

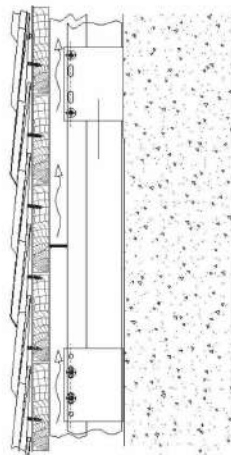

Classic, traditional appearance
Weather-tight at 45° and above
Quick and easy installation

elZinc® Tiles

Five different designs



elZinc® Diamond tile

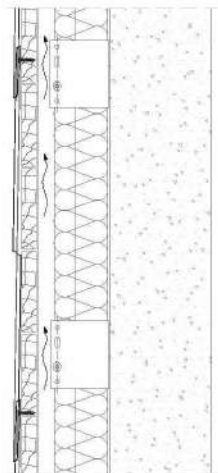
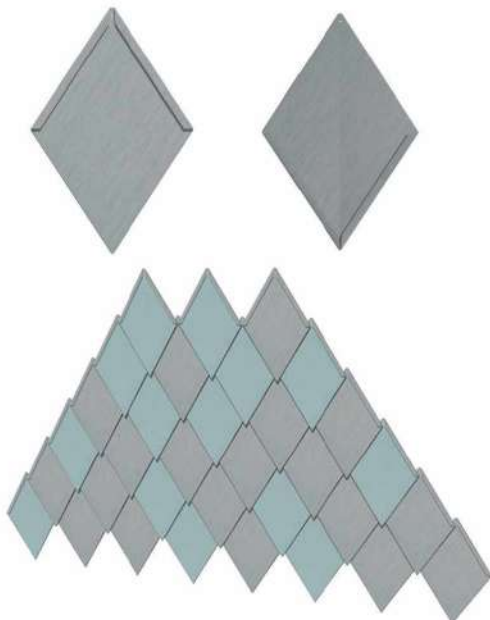

Elegant and modern aesthetic
Weather-tight at 25° and above
With additional clips provides greater
resistance to wind loading.

VITA STUDENT



Examples of typical details

Below are some examples of typical details. These and others, are available from our website. **elZinc®** also develops project specific details if required.

Details

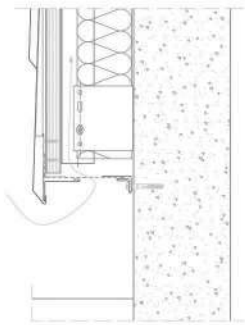

Ground level foot (square tile)



Front vented capping (square tile)

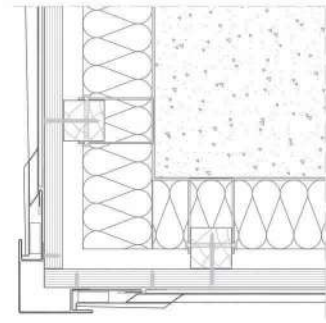

External corner (square tile)

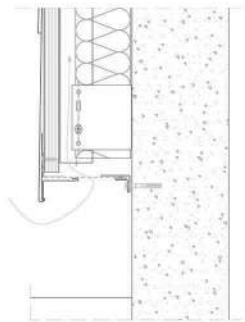

Ground level foot (Rhomboid tile)



Rear vented capping (Rhomboid tile)

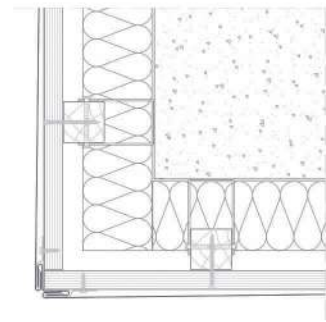

Rhomboid & Diamond tile internal corner

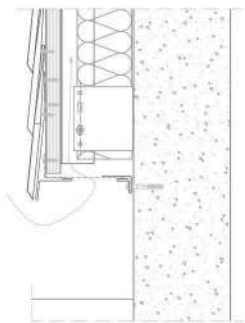

Ground level foot (fish scale tile)



Rear vented capping (fish scale tile)

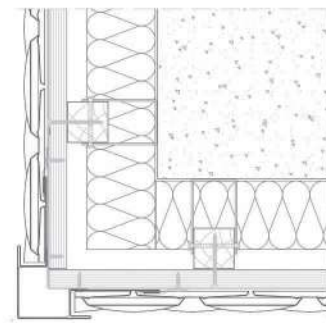

External corner (fish scale tile)



Engineered façades

These are façades that are constructed using self-supporting panels fixed or attached back to metal rails.

The principal systems are:

- Façade panel
- elZinc® composite material
- elZinc® honeycomb panel

Individual residence, Cape Town, South Africa.
BJK Architectural Technologist.



Vogue Building, Meudon, France



Engineered façades

Common characteristics

They include single skin **elZinc®** panels such as slot-in façade panels and cassette panels, and also **elZinc®** composite material and honeycomb material. They share the following characteristics.

Rainscreen design.

The joints between the panels are not 100% weather-tight, allowing some rainwater to drain down the backside of the panels during windy and rainy weather. A vented cavity behind the panels allows any moisture to evaporate and keeps the insulation dry. It also dissipates any moisture vapor that has penetrated through the insulation from the inside of the building.

Recessed joints

Shadow joints are normally used between the panels. The façade panel system uses a tongue and groove joint, but cassette panels (whether single skin or composite) are not physically connected together and sit independently on the façade, as do face-fixed composite panels. Hidden fix systems work by hanging the panels onto the supporting substructure.

Private residence, Bondi, Australia.
Lend Lease Design



Use of a metal supporting system

The system will usually allow for adjustment in two or three directions, depending on the structure behind. Most panel types fit back to a metal rail sub-construction.

Robust aesthetics

The joints between the panels create strong lines over the façade. The panel faces are flat (with none of the oil canning associated with traditional systems) and so create a solid look to the façade.

Residence North Melbourne, Melbourne, Australia
Jesse Judd.



Façade panel

Key points

- **Single skin self-supporting panels** with tongue and groove joint
- **Narrow aspect ratio** – length up to a nominal 4m, width up to 300mm
- **Suitable** for flat or gently curved façades and soffits
- **Panels** are normally installed in either a horizontal or vertical direction
- **Uses 1mm thick elZinc®**
- **Direct fixing** using screws or rivets to metal rail sub-structure

Basic system information

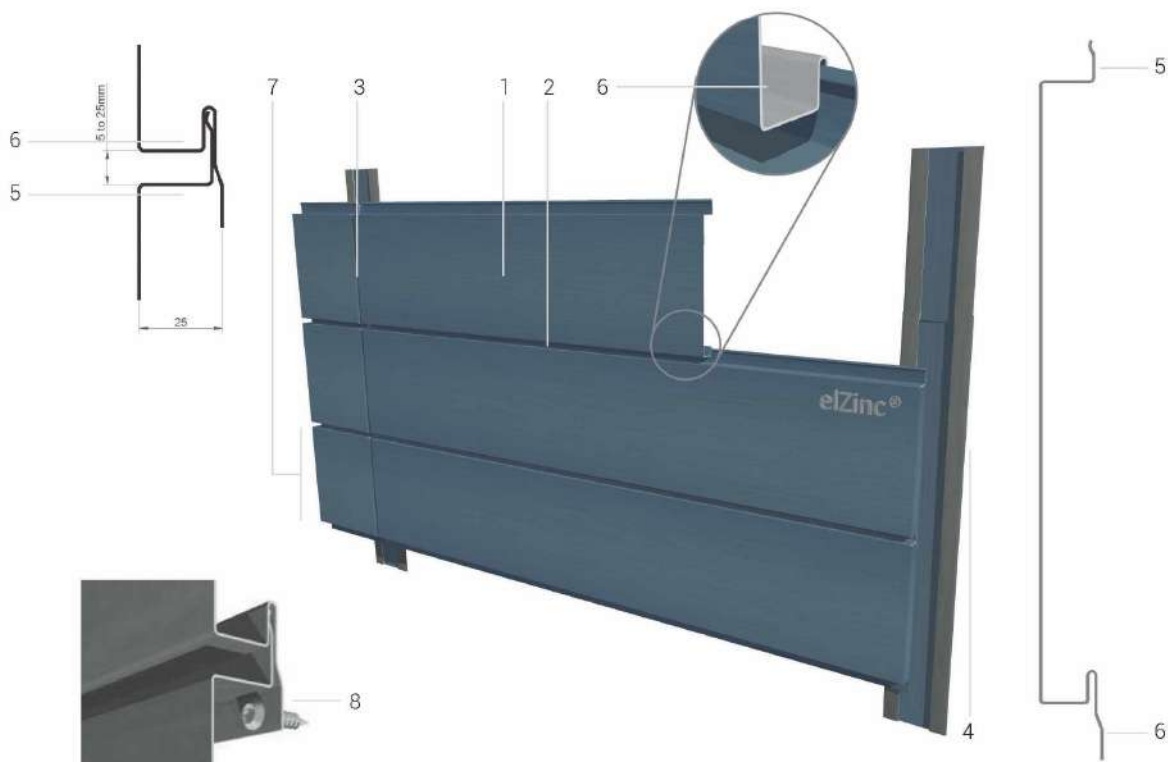

1. elZinc® profiled Façade panel. Maximum length nominally 4m.

2. Tongue and groove joint, can be varied from 5 to 25mm wide.

3. Transversal shadow joint.

4. Vertical weathering strip.

5. Tongue profile. Adjusts in length to vary joint width.

6. Groove profile

7. Joint centres dimension.

8. Direct fixing using self-drilling screws or rivets to rail profile sub structure (not shown).

Transverse joints

In a horizontal design, the cross joints can be achieved either by a reveal joint and weathering strip or by a sleeved joint, depending on the desired visual effect.

In a vertical design, the cross joints are normally achieved using an apron that weathers the joint.

Transverse joints

Horizontal panels - shadow joint with weathering strip.

Creates a shadow joint in the vertical and therefore establishes a grid pattern across the façade.

The width of the joint can vary from the minimums given below (to allow for thermal movement) up to 25mm.

- 1m panel – 4mm min.
- 2m panel – 5mm min.
- 3m panel – 7mm min.
- 4m panel – 8mm min

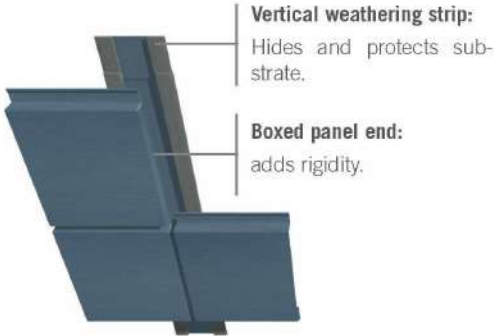

Horizontal - sleeved joint

A short sleeve is fixed to one end of the panel, over which the adjoining panel is slid.

Very discrete joint resulting in a completely horizontal design.

The same dimensions given above for the joint width apply here too.

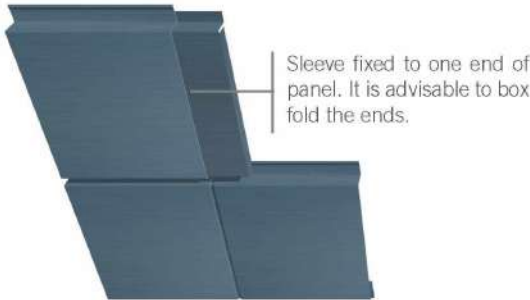

Vertical panels - Aproned joint

Weather-secure joint.

Visually robust (can be adjusted by modifying the face of the profile)

Divides the façade into horizontal segments.

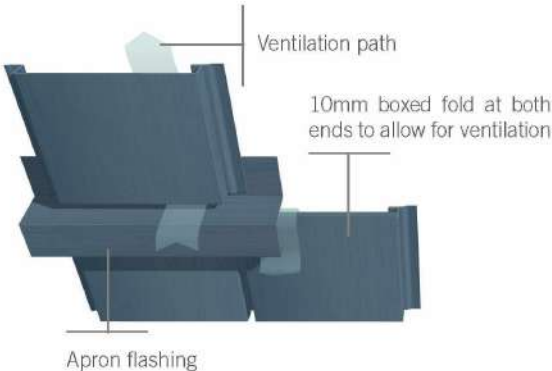

Façade panel

Appearance and layout options

The panels combine a flat solid feel with a certain delicacy due to their slim dimensions.

The panel joint's visual impact can be subdued or accentuated by the architect by varying its width from 5 to 25mm. If combined in the same façade, blocks of panels can be created to visually modulate the façade at greater intervals.

Fixing

The panels are screwed or riveted to the metal profiles behind. The spacing of the profiles should not exceed 60cm (where wind loading is high it should be reduced).

Basic system information

Uniform joint widths



'Blocking' of panels by using different joints widths

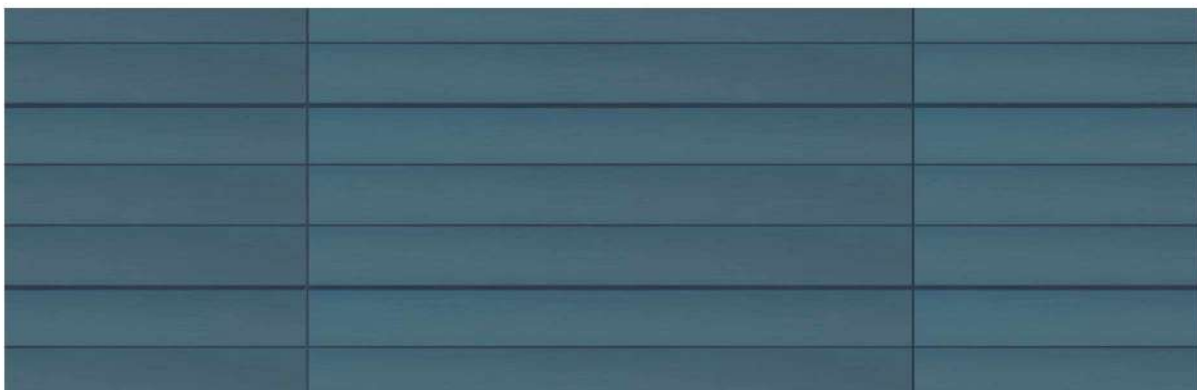

Examples of typical details

Below are some examples of typical details. These and others are available from our website. **elZinc®** also develops project specific details if required. For more detailed information on this system, please download the System Drawings pdf available from our website.

Details

Ground level foot **Front vented capping** **Rear vented capping**

External corner with corner piece **Internal corner with corner panel** **Reverse corner with corner piece**

Vented window sill **Vented window lintel** **Window jamb**

elZinc® Composite material

Key points

- **elZinc®** faced composite material
- Excellent **flatness and rigidity**
- **Large panel sizes** possible (1000mm x 8000mm max.) depending on installation system
- **PE** (B-s1, d0 according to EN13501) and **FR** (A2-s1,d0) cores available.
- **Can be curved**
- **Various fixing options** and sub structure types available

Hung cassettes

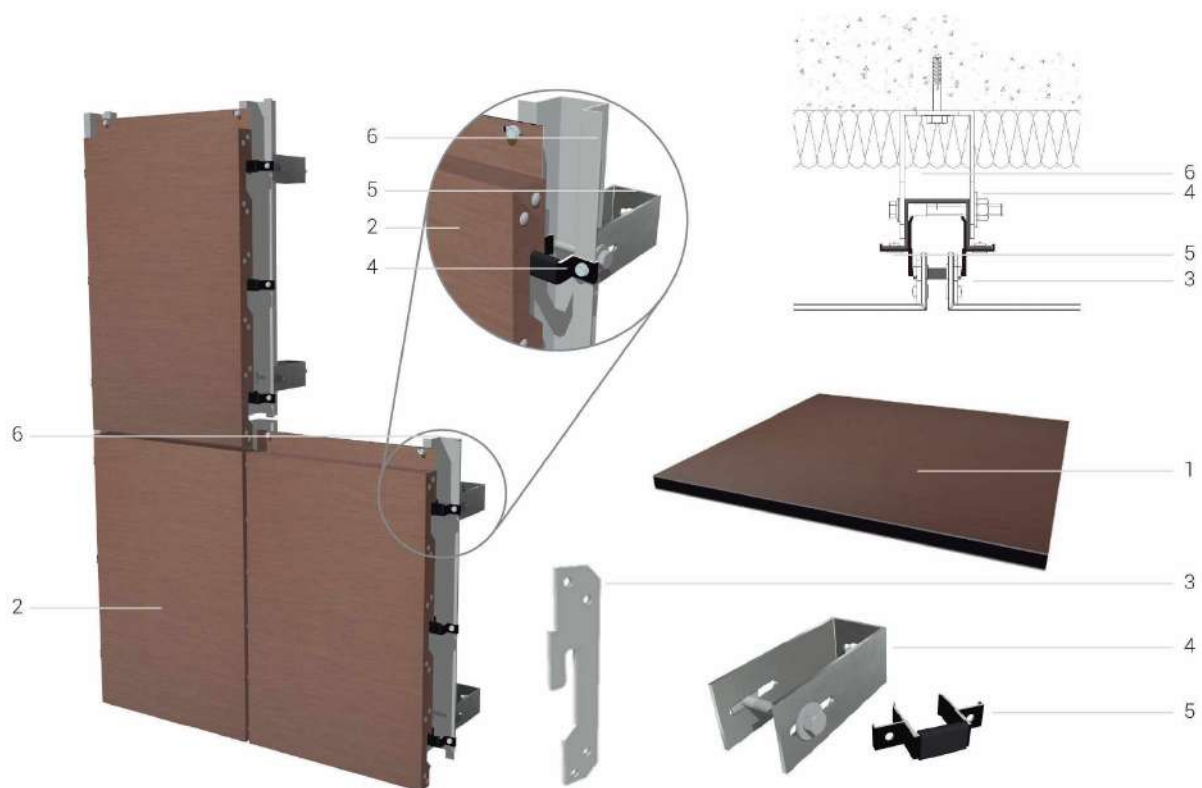

1. elZinc® composite material

2. elZinc® composite panel

3. Flange reinforcement

4. Adjustable wall bracket

5. Panel support with anti-vibration sleeve

6. Top hat profile



Tongue and groove system



1. elZinc® composite panel
2. Extruded aluminium profiles
3. Adjustable wall bracket
4. Top hat profile

Cassette system with simplified panel preparation:

Best in horizontal layouts - vertical panel edges are un-supported so panel height is limited – consult elZinc® for maximum panel height.

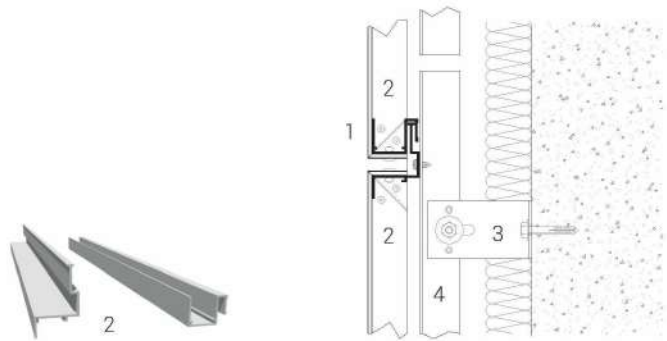

Maximum panel sizes:

Horizontal layouts: height 932 mm, length 7932 mm*

Vertical layouts: consult elZinc® for panel height, width 932 mm

Riveted system

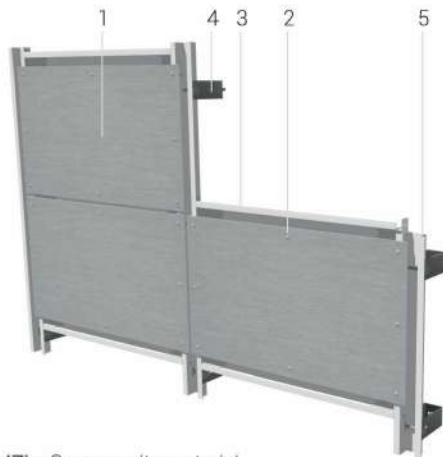

1. elZinc® composite material
2. Rivet fixing around elZinc® composite
3. Transome fixing bracket
4. Adjustable wall bracket
5. Top hat profile

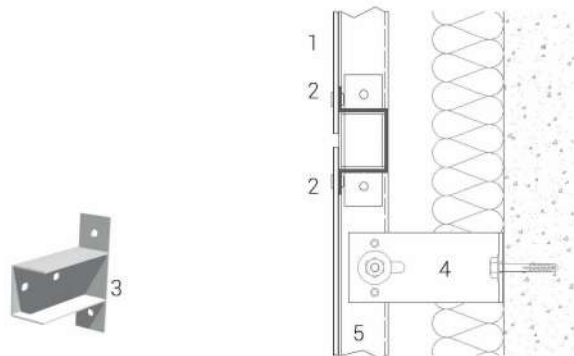

Simple and economical.

Maximum panel sizes:

- **Horizontal layouts:** height 1000mm, length 8000mm*

- **Vertical layouts:** height 8000mm, width 1000mm

elZinc® Honeycomb panel

Key points

- **elZinc®** faced aluminium honeycomb panel
- **Perfect flatness**
- **Extremely rigid**, very large panel sizes possible
- **A2 fire rating** (A2-s1, d0)
- **Bespoke**, point fixing system reduces sub structure costs
- **Quick and easy** precision installation
- **100% recyclable**
- Wrap around edges for **added safety**

Basic system information

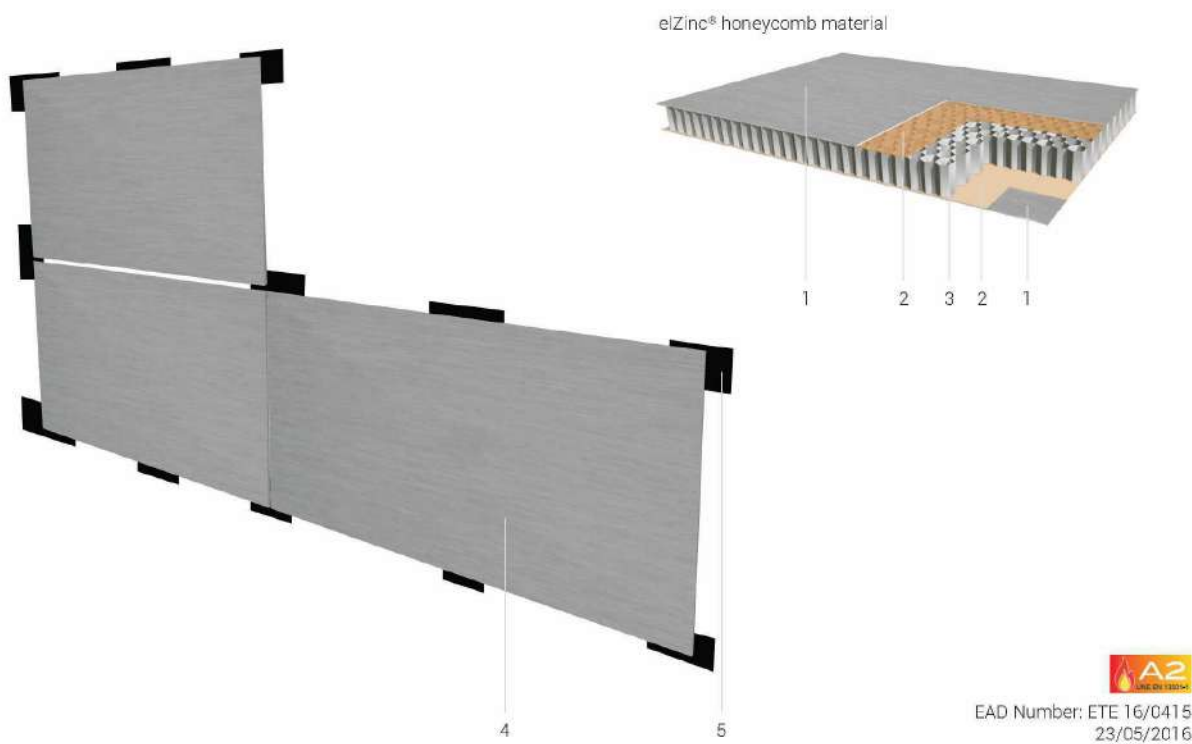

1. 0.5mm elZinc® panel skin

2. Adhesive

3. 14mm aluminium honeycomb core

4. elZinc® honeycomb panel

5. Point fixing system

Appearance

The rigidity of the **elZinc®** honeycomb material allows for very large panel sizes to be installed, either horizontally or vertically. At the time of going to press, finished panels of 936mm x 8000mm are possible, but the width will soon increase to around 1220mm. This makes for a very bold statement across the façade, with a minimum number of joints. The perfect flatness of the panels contributes to a sensation of solidity and robustness.

Certification

The entire system (panel + fixing system) is certified under the European Technical Assessment, part of the European Commission. The product has European Assessment Document (EAD) number ETA 16/0415 OF 23/05/2016. EAD's in the UK are recognized by BBA as being equivalent to BBA certificates.

Installation

The panels are installed on a bespoke point fixing system, specially designed to make the most of the extreme rigidity of the panel, eliminating the need for metal rails and reducing costs as a consequence. The fixing system is fully adjustable in three directions, facilitating perfect alignment of the panels. Its design also compensates for the thermal expansion and contraction of the panels.

The system also allows for easy panel replacement without having to disturb adjoining panels, including corner panels. This feature permits easy future periodic inspections behind the panels, to determine the condition of the thermal insulation for example.

Joints

The 20mm reveal joints can be left open or alternatively can be closed from the inside if desired. The outside **elZinc®** skin wraps around the edges and laps back onto the inside skin, where the two sheets are riveted together, producing a fail-safe fixing method of the panels to the supporting structure.

Panel Fabrication

Fabrication of the panels is carried out by standard CNC milling machines and a specially modified edging machine. This can be done either to order by **elZinc®** or by the cladding contractor.



5. Envelope construction



Les quais de l'Erdre Residential development, Sucé-sur-Erdre,
France - Atelier Pellegrino.





Layers in a traditional ventilated build up

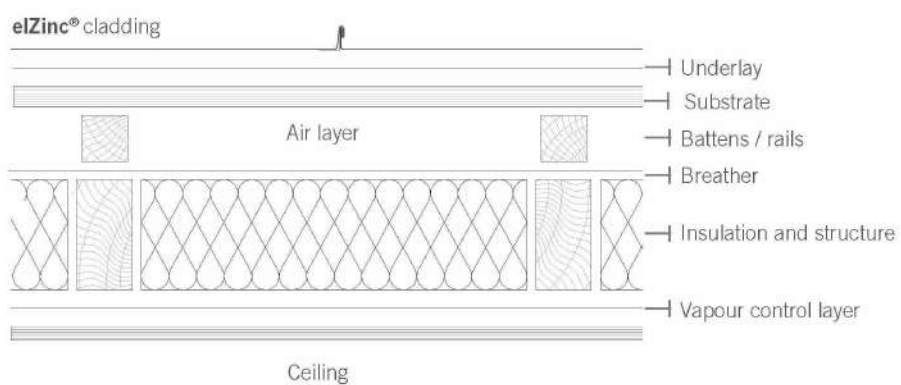

Envelope construction

Zinc is an excellent roofing and cladding material which will give long and almost maintenance-free service if installed properly. Proper installation means not only the correct fixing of the zinc itself, but also the correct design and installation of the supporting structure.

In traditional roofing and cladding this structure provides a continuous support for the zinc, whereas in engineered façades, metal railing and point fixing systems are employed. The information provided in this section can be used as a guide to the basics of zinc roof construction.

The building envelope is built up in a series of different layers on site. Depending on the design of the roof, **it can include, from outside to inside:**

- eIZinc® cladding
- Underlay
- Substrate
- Air layer (ventilated roofs and walls only)
- Insulation
- Battens or metal rails and wall brackets
- Vapor control layer / vapor barrier
- Principal load bearing structure

Layers in a typical unventilated build up

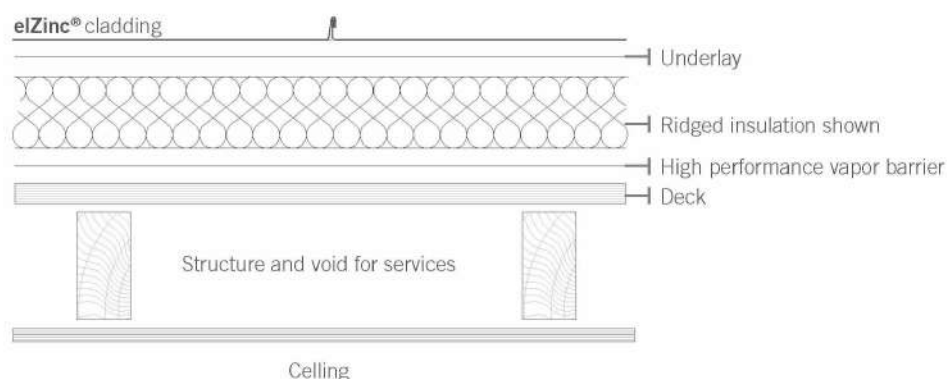

Underlays generally



An underlay is installed directly under the zinc. The underlay should be:

- Stable between -20°C and +80°C
- Not stick to the zinc
- Stable for up to 3 months outside in the sun
- Conform to EN 13859: 1 and 2

Its functions can include:

- Acting as a separating layer
- Acting as a slip layer
- Substrate protection during construction
- Draining condensate from the underside of the zinc

Structural underlays are commonly made of an air-permeable, fibrous mat, and are installed directly over the substrate or over a membrane. This mat lifts the zinc off the membrane or substrate below, providing a thin air layer (~8mm) which allows air to get to the underside of the zinc, drying out any condensed water vapour and preventing possible underside corrosion problems. If the mat is combined with a breather membrane (some types are available loosely bonded to a breather membrane) or other type of waterproofing membrane, it also facilitates drainage of condensate (or indeed any rainwater that penetrated the zinc in heavy weather) to the gutter.

Structural underlays are recommended by **elZinc®** on most roof types as they have proved beneficial to the longevity of zinc roofs.

They also:

- Reduce friction between the zinc and the membrane
- Reduce rain drumming noise by up to 8 dB
- Even out slight unevenness in the substrate

Higher standing seam clips must be used to compensate for the height of the mat. It is also important that operatives use a piece of plywood or similarly stiff board when kneeling on the zinc to spread the load and prevent the zinc from denting. The same applies to any other point loads.

Breather membranes that are used on **elZinc®** roofs and façades should have a maximum Sd value of 0.04m. Sd is the symbol for the Equivalent Air Layer Thickness, in m. The smaller the Equivalent Thickness, the less the resistance to moisture vapour transmission. There is a table in the appendix that relates Sd to MNS/g to Perms.

Peel and stick self-adhering waterproofing membranes with rubberized asphalt adhesive are commonly used on warm roof applications over metal, plywood, OSB, etc. substrates. The underlayment must self-seal around punctures such as nails, screws and staples and have a non-slip surface. Asphalt membranes are ideal for warm roof underlayment and are waterproof, protecting the roof from the weather until the zinc is installed. This can be especially important in countries with cold winters (such as Canada) where zinc work stops during the winter months, and in general in markets where commonly some time elapses between substrate completion and zinc work commencement.

The substrates

The substrate provides the structural support for the zinc, and generally the standing seam or flat lock clips are fixed to it. It should provide a minimum clip pull-out value of 560N. Surfaces that are single plane in geometry are simple to construct, curved surfaces can require a multi-layer approach of curvable thinner sheathing. Double curved geometry is best achieved by layers of softwood boarding.

Open gap boarding



This is formed from solid softwood boards of zinc compatible species fixed to wooden supports:

It should:

- Be fixed parallel to eaves, with a 2-3mm gap between boards, using countersunk screws or nails driven to just below the surface
- Use rough sawn boards 80 to 140mm wide, conforming to EN12775-2, with a moisture content of 18% or less
- Be treated with zinc-compatible wood preservatives
- Should have a max. difference of 2mm (+/-1mm) in height, both between boards and over the width of each board

Sheathing

Plywood, OSB or particle board sheathing is fixed using countersunk screws or nails to wooden or metal supports, driven just below the surface. The boards should be fixed as shown in the drawings on the following page.

It should:

- Have a 2-3mm gap between them
- Be protected from the rain before the **elZinc®** trays are installed
- Be supported at ≈600mm centres

Sheathing board thickness is generally around 18 to 24mm, and the boards themselves are 1200 – 1250mm wide by 2400 – 2500mm long.

Plywood should be specified as structural plywood according to EN 636:2003, class 2. This is suitable for external protected applications.

Orientated strand board (OSB) should be specified as complying with EN 300:2006 OSB/3 load bearing boards for use in humid conditions.

Particle boards should be specified as complying to EN 312:2010 class P5: load-bearing boards for use in humid conditions.

Insulating boards

Factory bonded insulation boards made of plywood and rigid insulation are used on warm roof designs. They avoid cold bridges and are quick to install, and provide a plywood or OSB deck for the **elZinc®** trays to be fitted to.

Rigid insulation

Rigid insulation is used on warm roofs and obviates the need for a timber substrate. The **elZinc®** trays are fixed through it to a deck below using a special clip.

The insulation should be able to:

- Remain stable at temperatures of up to 100°C
- Resist the compressive loads of foot traffic and kneeling operatives such that the **elZinc®** trays are not deformed

Sandwich panels

Metal skinned rigid insulation panels can be used as a substrate in warm roof construction. Their outer skin should be thick enough to ensure minimum clip pull-out values of 560N. They have good spanning properties making them useful on steel structures, and they eliminate cold bridges. The inner skin acts as a vapour barrier, and so the joints between the panels must be effectively sealed.

SIPs (Structural insulating panels)

Normally used on warm roofs over laminated wooden structures which take advantage of their spanning capabilities. The exterior wooden skin should be made of suitable grades of plywood, OSB or particle board and a minimum of 18mm thick.

Consult SIP's manufactures for advice regarding vapour control.

Open gap boarding laid in a staggered configuration

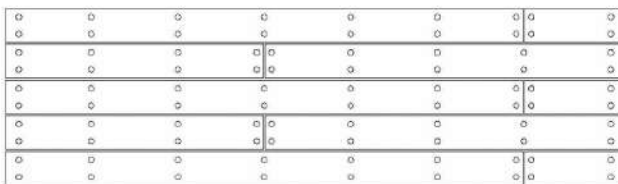

Sheathing laid in a staggered configuration

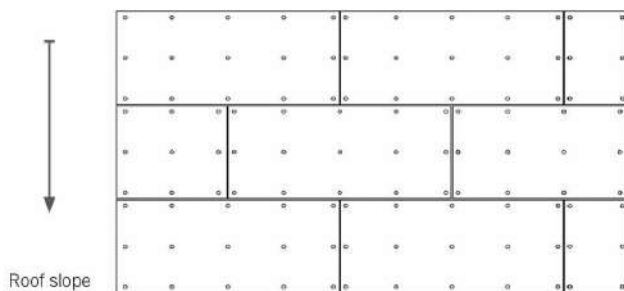

Profiled metal decking.

Installed to support traditional façades where its non-combustibility allows it to be used on taller buildings where fire regulations prohibit the use of wooden boards or sheathing. It is always installed 'façade side outwards' to give the zinc cladding the most support, and perpendicular to the longitudinal seams of the cladding. Its fixing must allow for thermal expansion and contraction. It should be thick enough to ensure a minimum clip pull-out value of 560N.

Wooden battens and blocks for zinc work

Wooden battens, blocks etc. should be treated with zinc-compatible preservatives, and have a moisture content less than 22% at the moment of zinc installation.

Substrate supporting materials: Metal profiles

Made of either extruded aluminium profiles or galvanised sheet, they are recommended to have a fixing face of 60mm. When supporting sheathing, they are set at centres of around 600 to 625mm, tying in with commercially available sheathing board widths and lengths.

Substrate supporting materials: Wooden lathes

Used more commonly to support soft wood open gap boarding, they should be regularised and appropriately treated with preservatives.



Compatibility with other building materials

Not all building materials are compatible with one another and care needs to be taken when selecting material to be in contact with, or draining onto, zinc roofing or cladding. The ill effects of not doing this can vary from light staining of the surface of the zinc to corrosion, so it is important that these potential hazards are designed out from the beginning. Note – the following is applicable to elZinc Natural and Alkimi. elZinc Rainbow and Advance products are undergoing testing at the time of writing and may be compatible under certain conditions with some of the materials or situations listed below – consult elZinc in these cases.

Metals

Different metals placed in contact with each other on the exterior of buildings must be compatible in order to avoid galvanic corrosion (also known as bi-metallic corrosion). Compatible metals with which elZinc® roofing and cladding can be placed in contact, with no effect on either metal: Aluminium, lead, stainless steel, galvanised steel. Incompatible metals with which elZinc Natural and Alkimi roofing and cladding should never be placed in contact with, or drain rainwater from: Un-protected steel, Iron, cast iron, copper, brass, bronze.

The more conductive the water (electrolyte) the faster the zinc will be affected. Salt water conducts electricity better than rainwater, so should galvanic corrosion occur it will be more serious in coastal environments than inland. If in doubt, seek the advice of your elZinc® distributor or contact elZinc® direct.

Timber

Timber combines well aesthetically with zinc on façades. However, many species of timber are used in building and those that have a low pH value, such as hardwoods and tropical woods can cause staining of zinc, or in some severe cases, corrosion.

Compatible timber with which all elZinc products can be used without reservation: Pine (Norway pine, Scots pine, European Silver Fir, Spruce, Fir (red and white) Poplar. These would be typically used as the timber in open gap boarding substrates, without a separation layer between the zinc and the.

Additionally, All elZinc® products can be used without reservation with softwood plywood and OSB, which would be used as the sheathing substrate with a breather membrane (and possibly a structural mat) placed between the zinc and the sheathing.

Incompatible timber which should not be in contact with or shed run-off onto elZinc® Natural or Alkimi: Tropical woods, Douglas pine, Larch, Oak, Chestnut, White and red Cedar.

Wood preservatives.

Nowadays wood preservatives pose few problems for zinc roofing and cladding. Organic products and emulsions can be used. Non-fixed metal salts are incompatible as the release of the metals they use (such as copper) can harm the zinc.

For more information, contact elZinc.



Bituminous products, sealants and adhesives.

Bituminous membranes breakdown on exposure to the sun, releasing compounds that can harm zinc. Zinc should therefore be separated from bitumen membranes by appropriate means, and bitumen membranes draining rainwater onto zinc products should be protected from sunlight by at least 5cm of gravel.

Two component acid system sealants can potentially cause corrosion and staining of elZinc products and should not be used. Neutral curing mastics and silicones are fine, as are Polyurethane based sealants and MS polymer sealants. For colour matching the sealant to an

Sometimes an adhesive is required to attach accessories (such as the bird spikes below). Neutral curing silicones, MS polymers and polyurethane based adhesives are all compatible with elZinc products.

Consult elZinc® for the compatibility of adhesive tapes.

Cement.

Amongst other ingredients, cement contains lime (calcium oxide - CaO) and calcium silicate (Ca₂SiO₄) that can react with zinc when fresh. Once cured, no reaction occurs, but the zinc should be separated from it by a breather membrane.

Plaster of Paris.

Generally does not pose a problem to zinc due to its fast curing time.

Fibre cement boards.

Cutting fibre cement boards produces cement dust that if allowed to settle onto zinc roofs in humid conditions, or it rains afterwards, can cause lasting staining.

Magnesium oxide boards.

Pending study – contact elZinc® for more information.



Bird spikes attached using neutral curing silicone



Aluminium window frame sealed against the elZinc Rainbow® Brown sill using brown neutral curing silicone



Thermal design

Roofing

Two designs are commonly used with **elZinc®** – the ventilated roof and the unventilated roof, also known respectively as the cold roof and warm roof.

Choosing which design is the most appropriate for a particular project depends on many factors such as roof form, available height, cost, and aesthetics.

This is best discussed on a project by project basis with our technical department. However, as a guide the following general comments are made below.

Ventilated (cold) roofs work best with:

- A decent pitch
- Simple geometry
- Adequately dimensioned air gap

They are not so appropriate for:

- Low pitched roofs (unless good cross ventilation can be provided, which limits the rafter length)
- Roofs where the required height of the air layer is problematic
- Geometrically complicated roofs (where it is difficult to achieve enough drive to get the air moving through the layer)
- Where ridge details are required to be as discreet as possible
- Where the cost is prohibitive

Unventilated (Warm) designs are more sensitive to the construction process itself:

- Installation over humid substrates which traps moisture
- Improper installation of the vapour barrier which allows moisture migrating through the roof to condense (in cold weather) on the rear face of the zinc

However, their effectiveness is not dependent on:

- The pitch of the roof
- The complexity of the roof's geometry

A warm roof also allows for a slimmer roof construction which can be important visually on some projects.

Day care center, South Korea.



Façades

Traditional façades are generally ventilated, with an inlet at the foot of the cladding and an outlet at the head. This is because the vertical nature of vented façades means the air layer is working at its best and dissipates diffused moisture vapour effectively. This keeps the building envelope dry in the winter months and helps to cool the building in the summer.

Kyungpook University, South Korea.



Examples of roof types

Ventilated (cold) roofs

These designs introduce an air layer under the substrate which draws warmed, moist air out from under the zinc. This layer also helps to dissipate heat in the summer months, keeping the building cooler.

Air inlets and outlets are created at the eaves and ridge of the roof, using perforated **elZinc®** material as an insect mesh. The net area required depends on roof pitch and is given opposite.

If a structural underlay is required, any draining membrane installed below it should be a breather membrane, since any condensate will evaporate down through it and the substrate into the air layer, where it is drawn out from the roof via the outlet.

Vented roof on sheathing

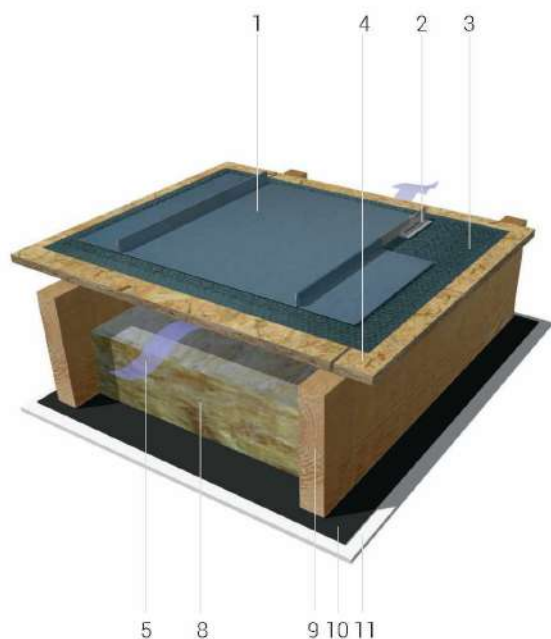

Vented roof on softwood boarding

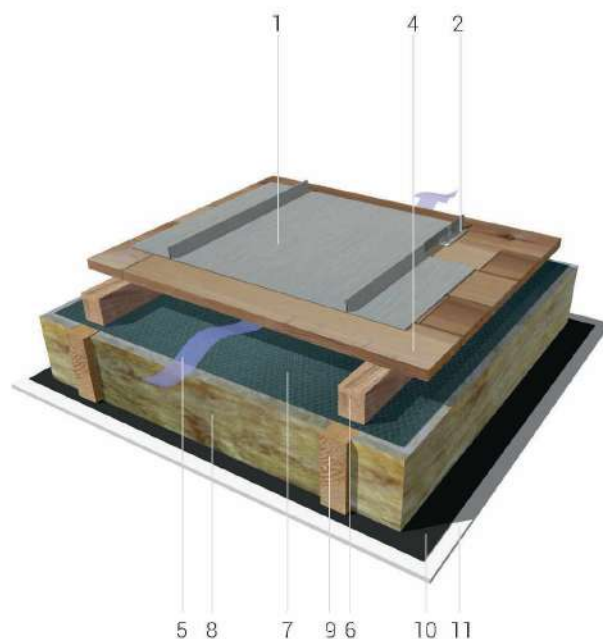

1. elZinc® standing seam tray
2. Standing seam clip
3. Underlay (structural underlay + breather)
4. Substrate
5. Ventilation path / air gap
6. Air layer batten (height = air layer thickness)

7. Breather membrane over insulation, $s_d < 0,04\text{m}$
8. Insulation
9. Wooden rafter
10. Vapour control layer with sealed laps
11. Ceiling finish

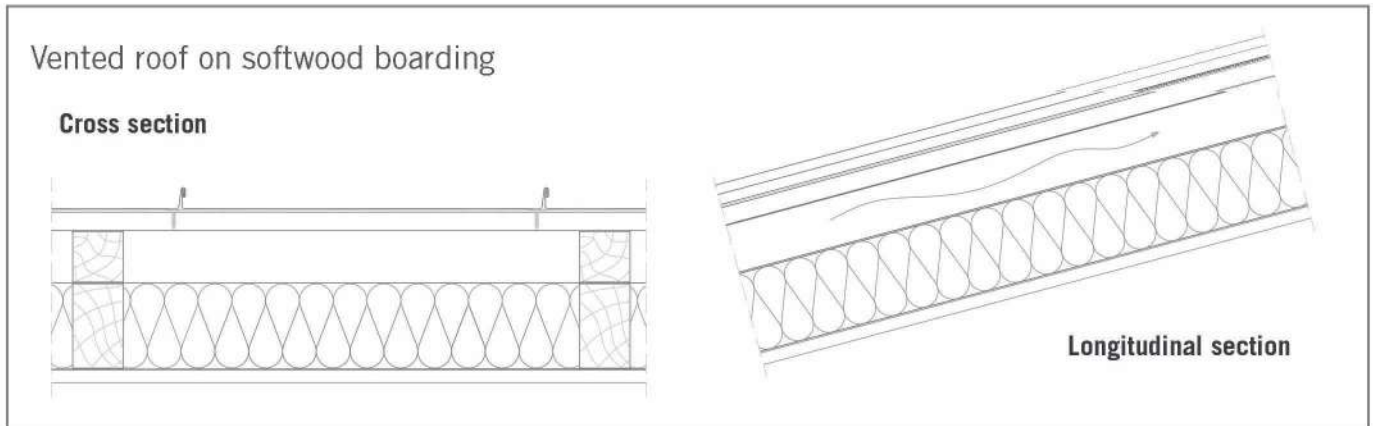

Details:

Underlays:

Open gap boarding $\leq 15^\circ$: Structural underlay optional

Open gap boarding $>15^\circ$: None required

Sheathed boarding all pitches: Structural underlay + breather

Air gap:

Ventilating layer height is varied according to its length and its pitch. The greater of the two values is taken.

Rafter length $<10\text{m}$: 5cms

Rafter length $>10\text{m}$: 10cms

Pitch $< 20^\circ$: 8cms

$20^\circ < \text{pitch} < 60^\circ$: 5cms

Pitch $> 60^\circ$: 4cms

Air inlets and outlets:

Net air inlet: $3^\circ < \text{pitch} < 20^\circ$: 1/500th of roof area

Pitch $>20^\circ$: 1/1000th of roof area.

Net air outlet: $3^\circ < \text{pitch} < 20^\circ$: 1/400th of roof area

Pitch $> 20^\circ$: 1/800th of roof area.

Mesh:

Round holes or slots, approx. 5mm diameter /width.

Vapour control layers:

These are used to limit the moisture being drawn into the air layer, and are more important nowadays since ever increasing insulation requirements weaken the air drive through the layer. Typical S_d values should be $> 100\text{m}$.

Substrate:

Fixed perpendicular to the direction of the standing seams with a 2-3mm gap between boards.

Substrate options (in decreasing quality):

- Open gap softwood boarding
- EN 636 class 2 plywood
- EN300 class 3 OSB
- EN312 class P5 particle board

Breather membrane over insulation:

Recommended for roofs on softwood boarding and pitched below 30° . Its principal function is to protect the insulation from the possibility of condensate dripping onto it in adverse climatic conditions.

Example of roof types

Unventilated (warm) roofs

These designs incorporate a high performance, and when required, self-sealing vapour barrier on the warm side of the insulation. The effectiveness of this vapour barrier is of paramount importance to the roof, so:

- Its installation should be carefully controlled on site
- All joints and penetrations should be sealed
- It should wrap around all edges of the insulation

- It should always be installed over a structural deck

Any membranes used under the structural underlay mat are either breather membranes, peel and stick type membranes or bitumenous waterproofing type membranes, depending on climate, market and local building practices. Contact **elZinc®** or you local representative for specific information.

Ridged insulation substrate

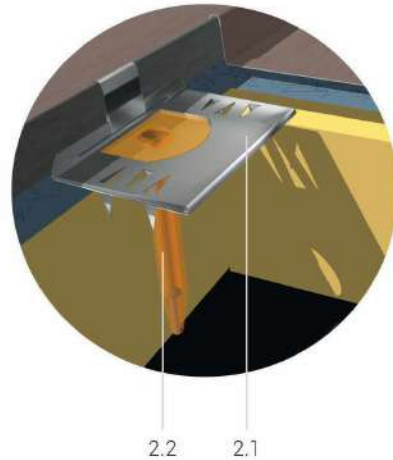
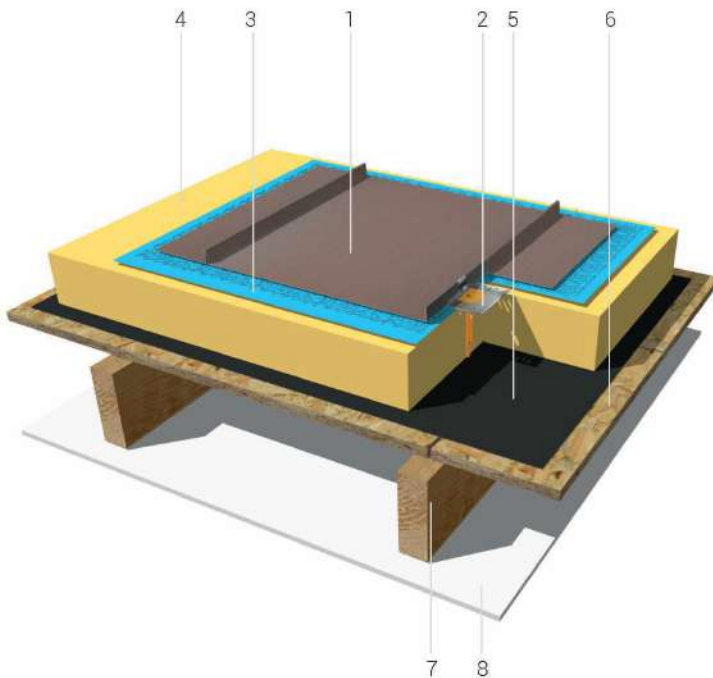

1. elZinc® standing seam tray (elZinc Protect+ recommended)
2. Standing seam 'warm-fast' clip
 - 2.1. Stainless steel grip plate
 - 2.2. Spacer plug
3. Structural underlay with water proof membrane
4. Rigid insulation
5. Self-sealing high performance vapour barrier
6. Decking (plywood, OSB).
7. Wooden rafter
8. Ceiling finish.

Substrate:

The insulation should be stable up to 100°C, and not permanently depress under foot traffic or kneeling operatives.

Vapour barrier:

Typical Sd values should be $\geq 1500m$.

Decking:

Plywood or similar can be used. Only one screw is used per clip, so pull-out values and clip centres should be checked, and deck thickness adjusted.

Foamglas warm roof

Other supporting structures are possible – please contact Foamglas for more information

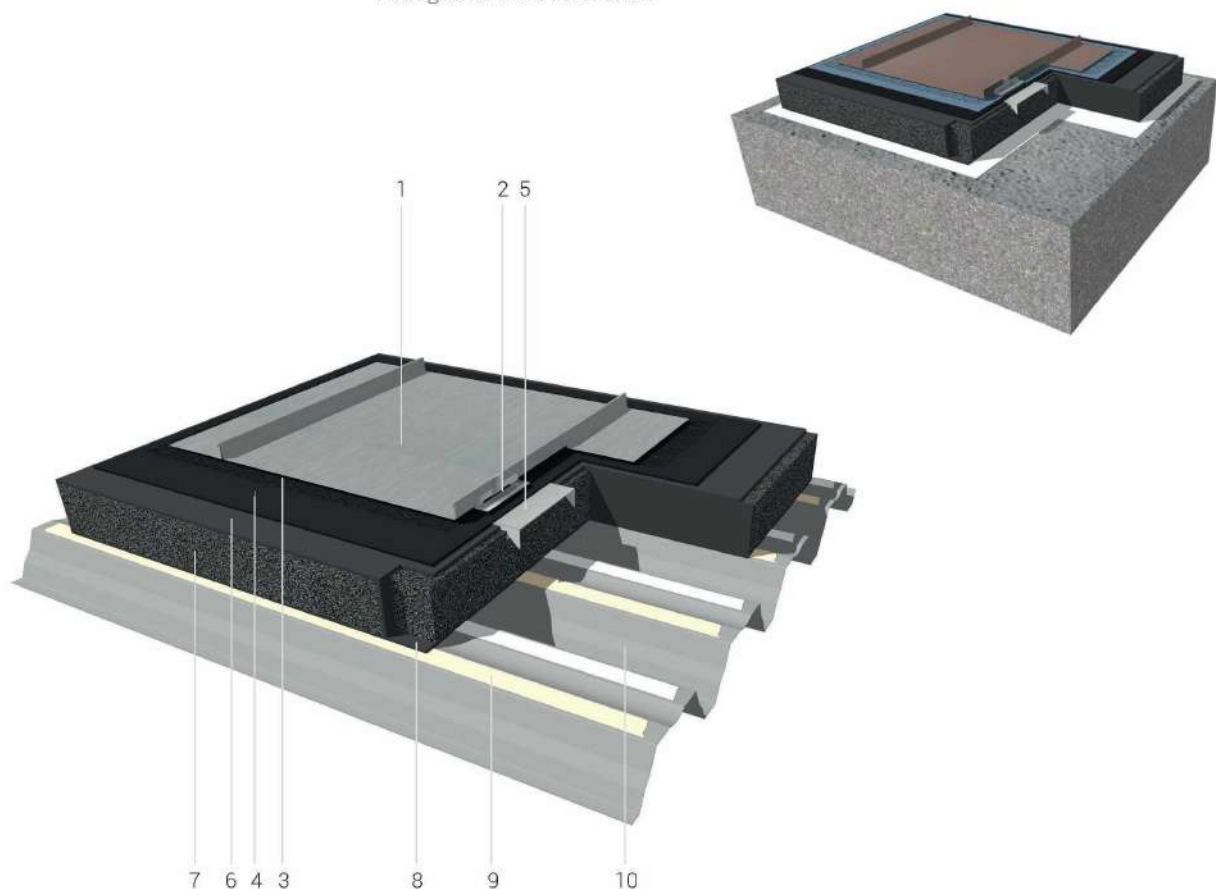

1. elZinc® standing seam tray (elZinc Protect+ recommended)
2. Standing seam clip
3. Structural underlay
4. Bitumenous waterproofing membrane
5. Serrated fixing plate
6. Hot bitumen top coat
7. Foamglas closed cell insulation (previously dipped in hot bitumen)
8. Hot bitumen bottom coat (from dipping insulation boards)
9. Self adhesive layer
10. Trapezoidal roof deck

Substrate - Foamglas insulation:

All information given here is indicative. The system itself is the insulation and the vapour barrier. Contact the manufacturer for project advice.

Trapezoidal metal deck:

Foamglas should be contacted to verify the validity of the trapezoidal deck, as deflection limits are imposed on it by the insulation system.

Examples of unvented roofs

Insulation boards

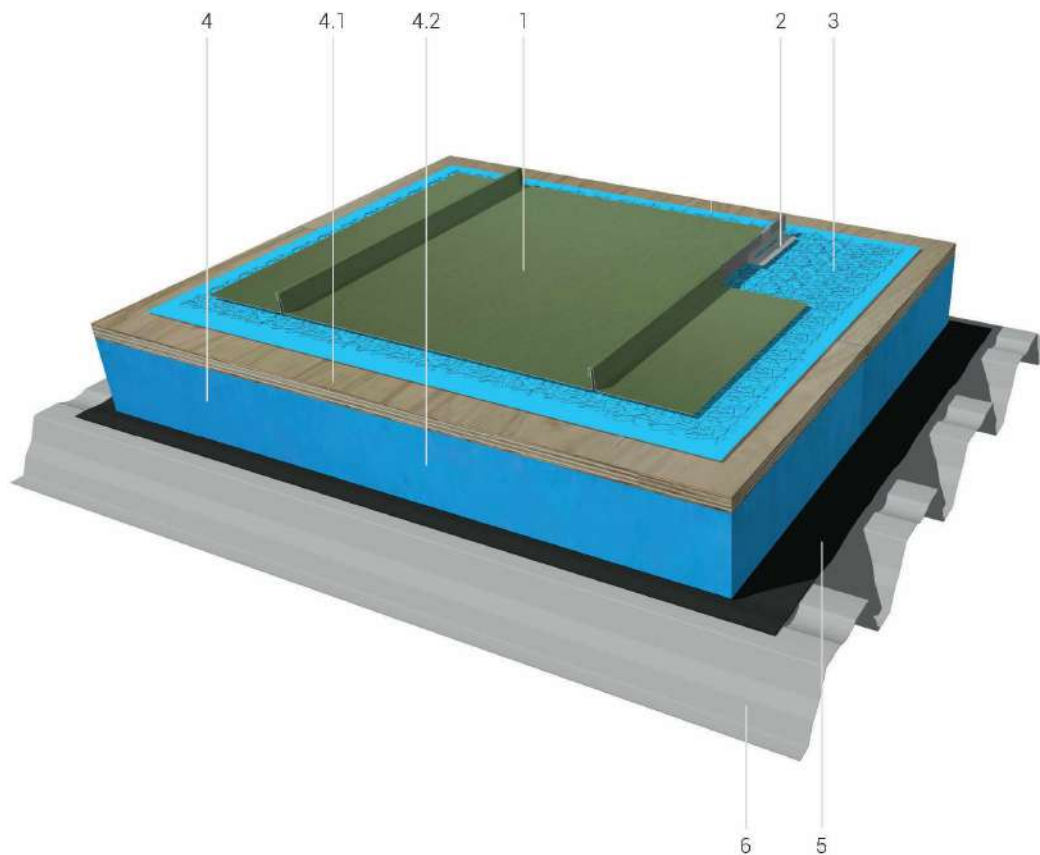

1. elZinc® standing seam tray (elZinc Protect+ recommended)
2. Standing seam clip
3. Structural underlay with waterproof membrane
4. Rigid insulation board
 - 4.1. Plywood decking
 - 4.2. Insulation
5. Self-sealing high performance vapour barrier
6. Metal trapezoidal deck

Substrate:

To be fixed according to the manufacturers' instructions

Vapour barrier:

Typical Sd values should be $\geq 1500\text{m}$.

Must be suitable for laying over a trapezoidal deck

Carrier panel warm roof

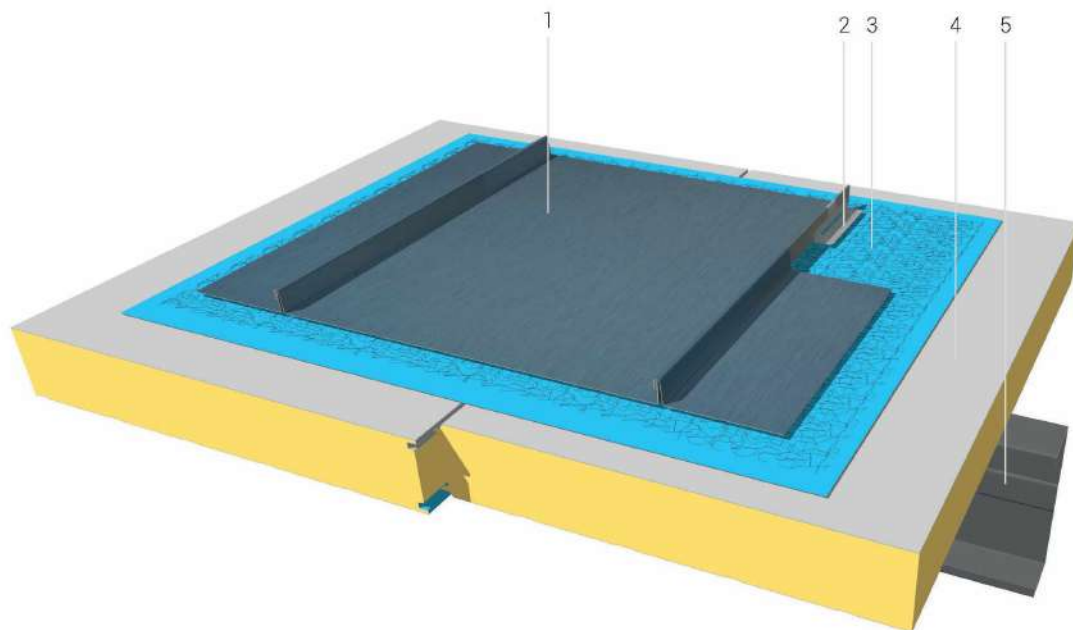

1. elZinc® standing seam tray (elZinc Protect+ recommended)
2. Standing seam clip
3. Structural underlay with waterproof membrane
4. Metal sandwich carrier panel
5. Structure

Standing seam clips:

These should be fixed using fasteners able to achieve a pull out value of 560N or greater per clip.

Carrier panel:

Carrier panels have a thicker outside skin ($\geq 0,7\text{mm}$) to ensure pull-out values for the clips are maintained at 560N per clip or more. Installation should be according to the manufacturer's instructions. It is vitally important that all panel joints are vapour-tight, the same is true for all perimeters of the panel installation.

The fixings of the carrier panel to the steel structure are normally visible from the inside.

Examples of ventilated façades

Ventilated façades fixed to wooden substrates

The ventilated façade incorporates an air gap behind the substrate which is connected to the outside air via an inlet at the foot and an outlet at the head of the cladding, and also at window sills and lintels.

Perforated zinc is used to provide an insect mesh along these openings. Structures that are not airtight may need an airtight membrane installed.

Façade on open gap boarding

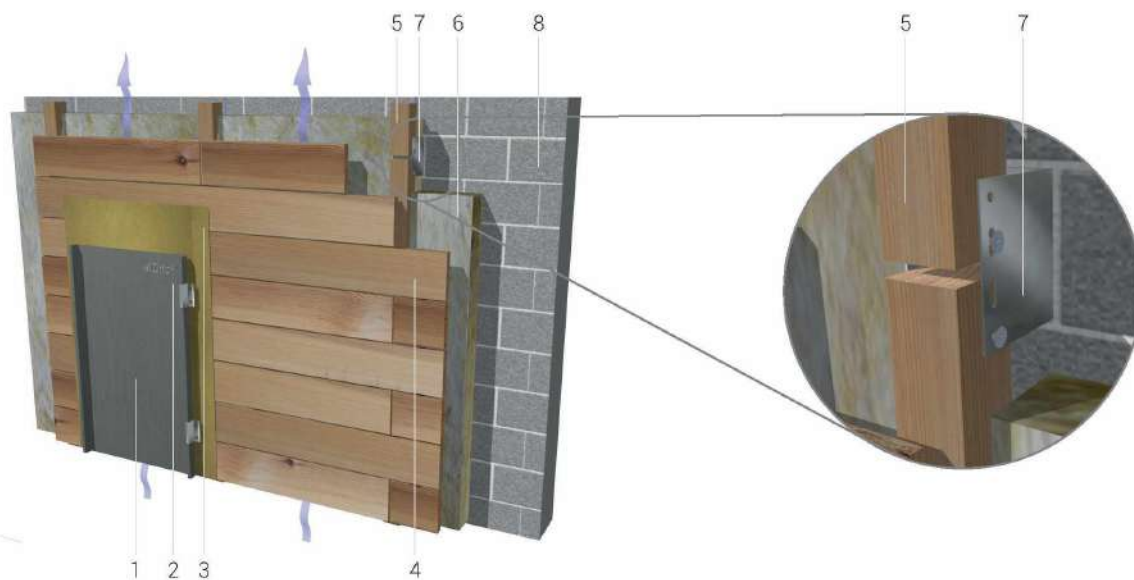

Sheathed vented façade

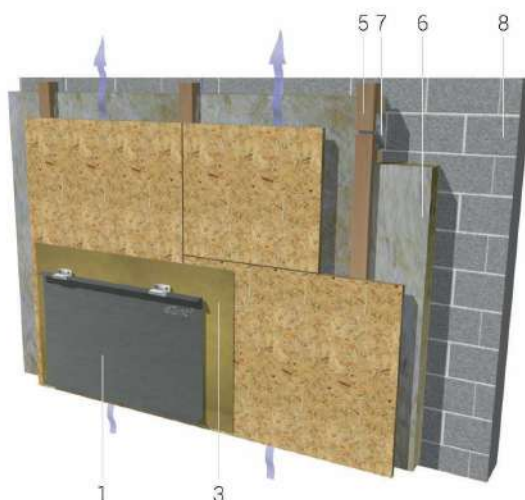

1. elZinc® traditional cladding (angle standing seam shown)
2. Seam clip
3. Breather membrane underlay
4. Substrate
5. Wooden battens @ ≈600mm centres
6. Insulation between battens
7. Wall bracket
8. Solid wall

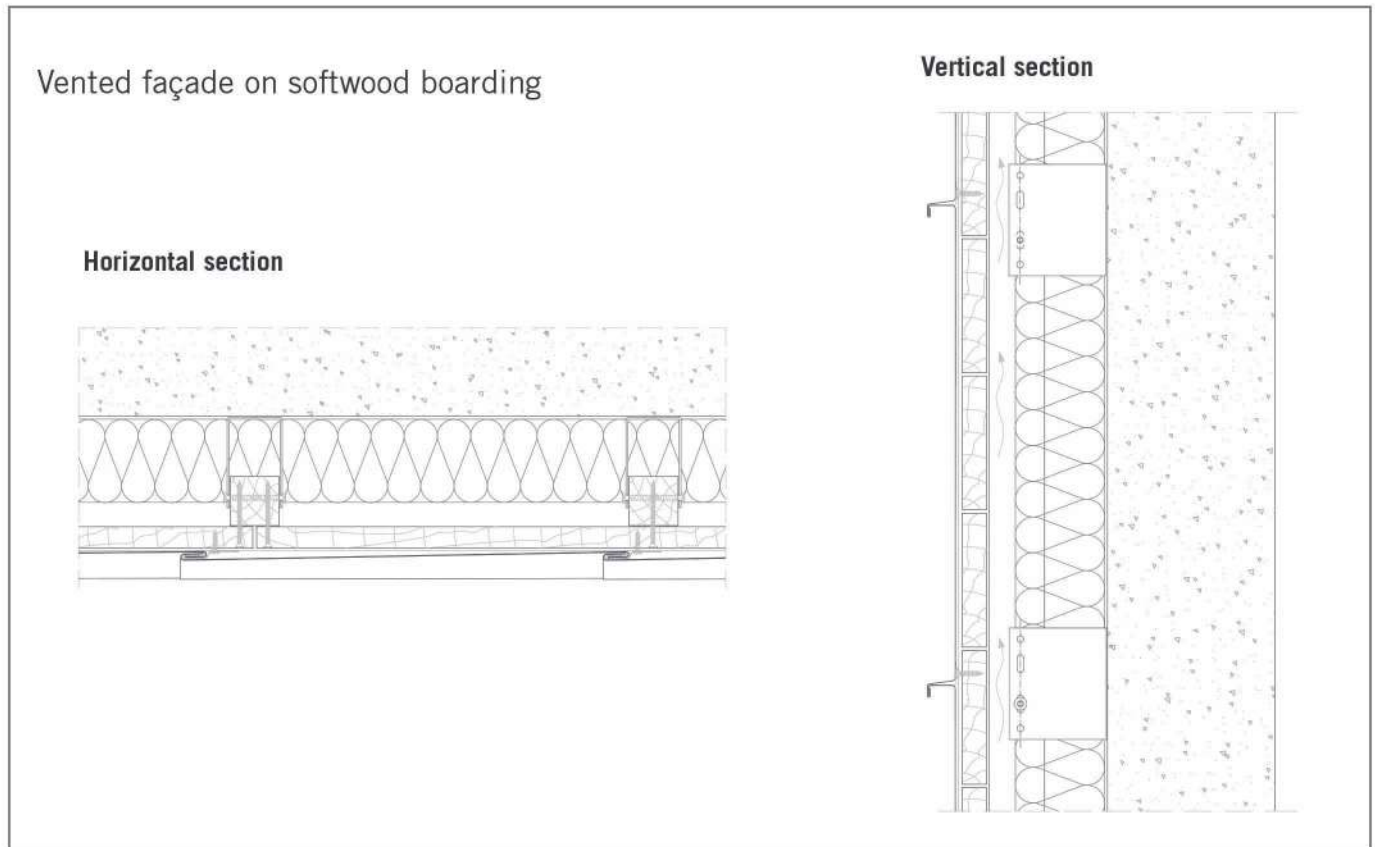

Details:

Substrate:

Fixed perpendicular to the direction of the seams with a 2-3mm gap between boards.

Substrate options (in decreasing quality):

- Open gap soft wood boarding
- EN 636 class 2 plywood
- EN300 class 3 OSB
- EN312 class P5 particle board

Air gap:

20mm minimum, some countries require more, usually up to 40mm (eg. residential projects in UK generally require 38mm).

Underlay:

Underlays are optional with open gap boarding, (for weather protection before zinc installation for example). With other substrates a breather membrane is used as a separation layer.

Supporting battens or rails:

Plumbed and even to create a flat plane for the fixing of the substrate. They are fixed back to the main structure by means of adjustable wall brackets.

Ventilated façades

Ventilated façades fixed to trapezoidal sheet

In many countries, façades over a certain height are required to be constructed of non-combustible materials. In these cases, trapezoidal metal decking is commonly used instead of wooden substrates.

Profiled metal decking on blockwork

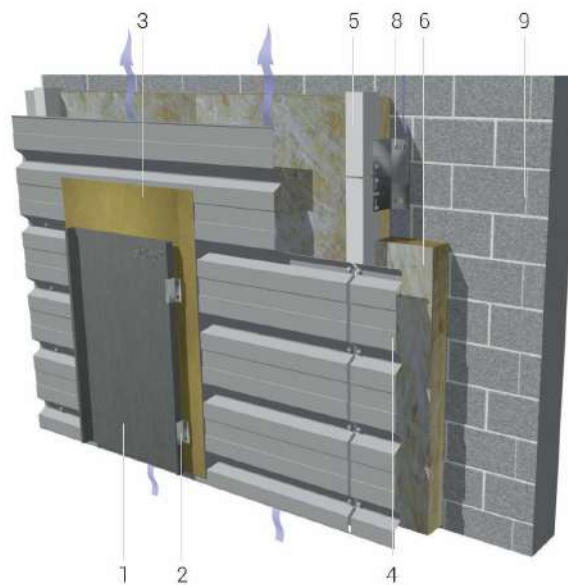

Profiled metal decking on steel structure

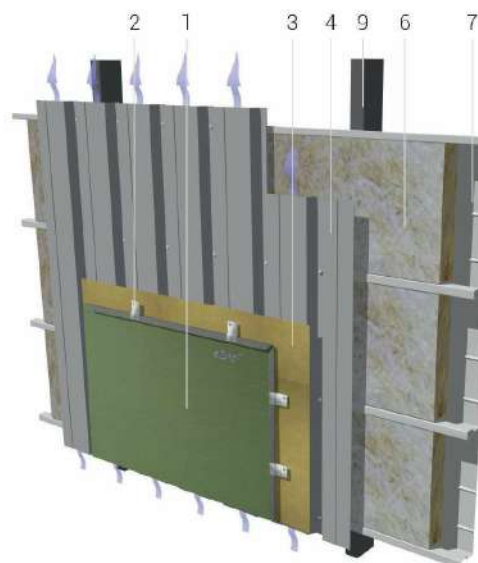

1. elZinc® traditional cladding (angle standing seam and flat lock panels shown)
2. Seam clip
3. Breather membrane underlay
4. Profiled metal decking
5. Metal profiles
6. Insulation
7. Structural liner tray
8. Adjustable wall bracket
9. Structure

Façade on trapezoidal metal decking

Horizontal section

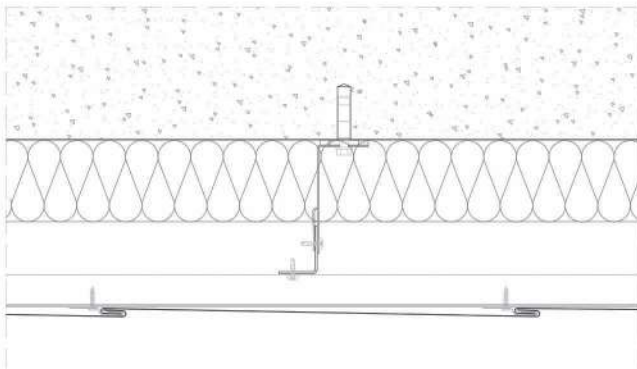

Vertical section

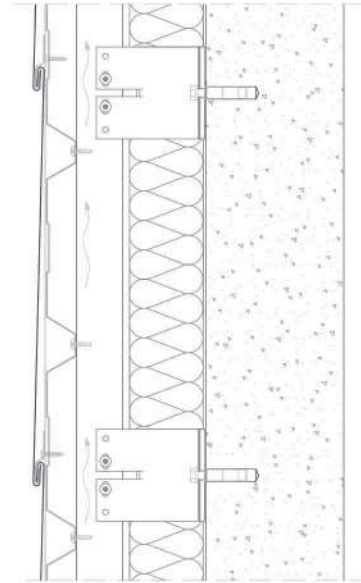

Details:

Underlay:

A breather membrane is used as a separation layer.

Metal decking:

It is fixed perpendicular to the direction of the seams. Vertically fixed decking ventilates through its own section.

Air gap:

20mm minimum, some countries require more, usually up to 40mm (eg. residential projects in UK require 38mm).

Wall brackets:

'Helping hand' type wall brackets are adjustable and allow for thermal movement of the metal profiles. **A range of bracket depths** allows for varying insulation thicknesses and structure unevenness. A thermal break can be inserted **between the bracket and the wall** if required.

Structural liner trays:

These products have good spanning characteristics and can be micro-perforated for acoustic purposes.

Residential development, Suresnes, France - Schemaa.



Engineered façades

Zinc is an excellent roofing and cladding material which will give long and almost maintenance-free service if installed properly. Proper installation means not only the correct fixing of the zinc itself, but also the correct design and installation of the supporting structure.

In engineered façades, metal railing and point fixing systems are employed.

Offices High Valley, Meylan, France.



Multifamily development, Australia
SJB.



Engineered façades

Single skin façade panels

elZinc® façade panels are installed in rear-ventilated rain-screen systems. Since they are self-supporting they do not require a continuous substrate, and so are fixed back to metal rails. There is an air gap between the back of the panels and the insulation.

Thermal expansion and contraction of the **elZinc®** panels is allowed for by the gentle flexing of the metal rail – wall bracket assembly. At the end of each panel, there are two metal profiles fixed next to each other which act as an expansion joint – see diagrams opposite.

Vertical metal profiles fixed with helping hand brackets

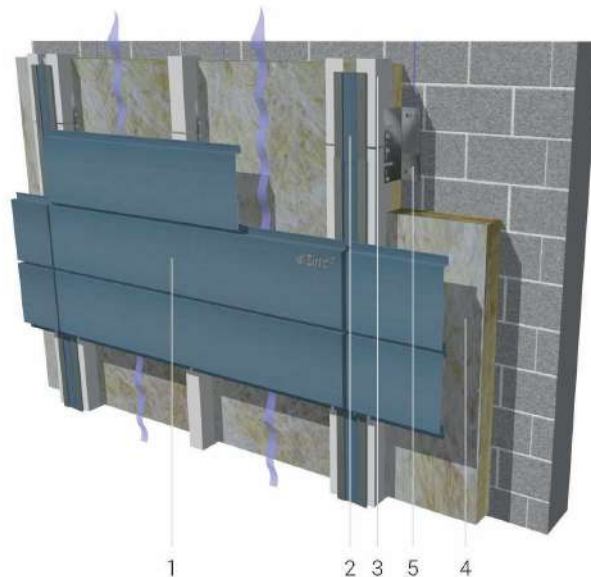

Horizontal metal profiles fixed with helping hand brackets

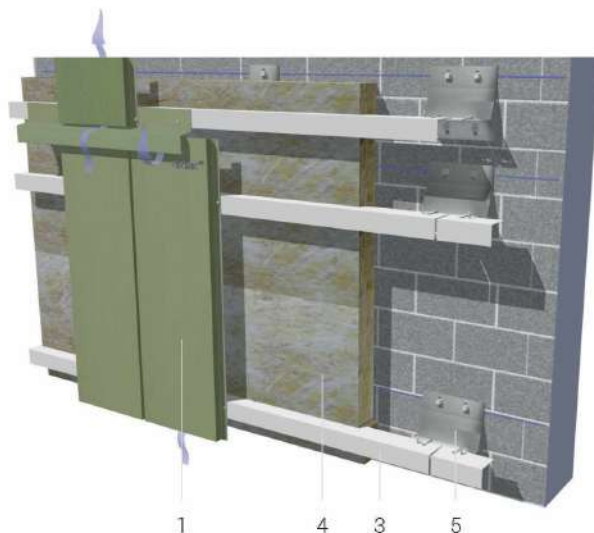

1. **elZinc®** façade panel
2. Vertical joint liner
3. Metal rails
4. Insulation between rails
5. Adjustable wall bracket

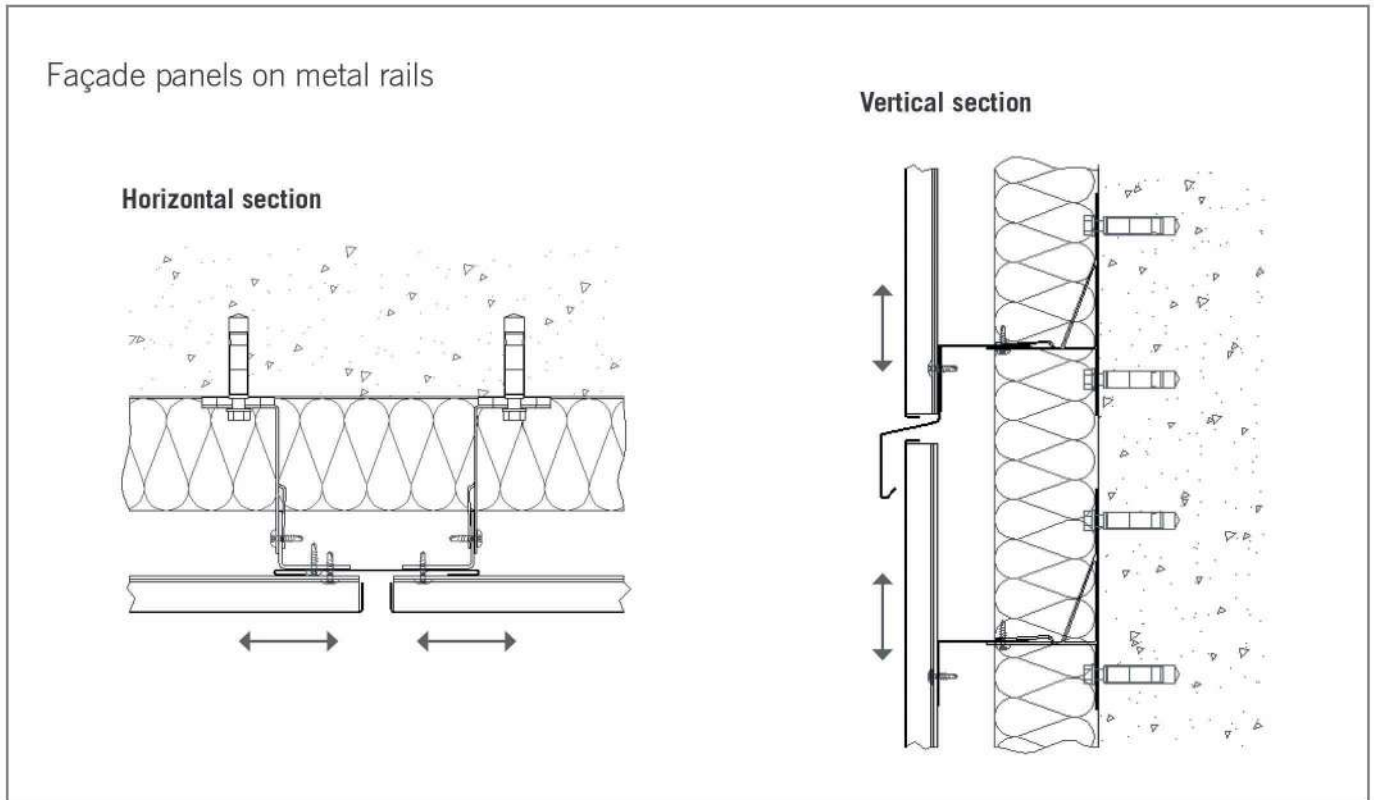

Details:

Air gap:

20mm minimum, some countries require more, usually up to 40mm (ex. residential projects in UK require 38mm). Vertically installed panels ventilate through their sections.

Metal rails:

Extruded aluminium or galvanized steel. Fixed at centres according to wind loading which normally comes out at between 500 and 600mm. They should have a front face of at least 50mm.

Wall brackets:

'Helping hand' type wall brackets are adjustable and allow for thermal movement of the metal profiles by flexing slightly. A range of bracket depths allows for varying insulation thicknesses and structure unevenness. A thermal break can be inserted between the bracket and the wall if required.

Engineered façades

elZinc® Composite material

These systems have bespoke installation solutions specially designed for the **elZinc®** composite material. They are all rainscreen systems (rear vented and drained) and have open joints.

Every project is calculated according to its design wind loading which gives the maximum panel sizes possible, the panel reinforcements required (if any and depending on system) and the centres of the supporting profiles.

Hung cassettes, tongue and groove and riveted systems

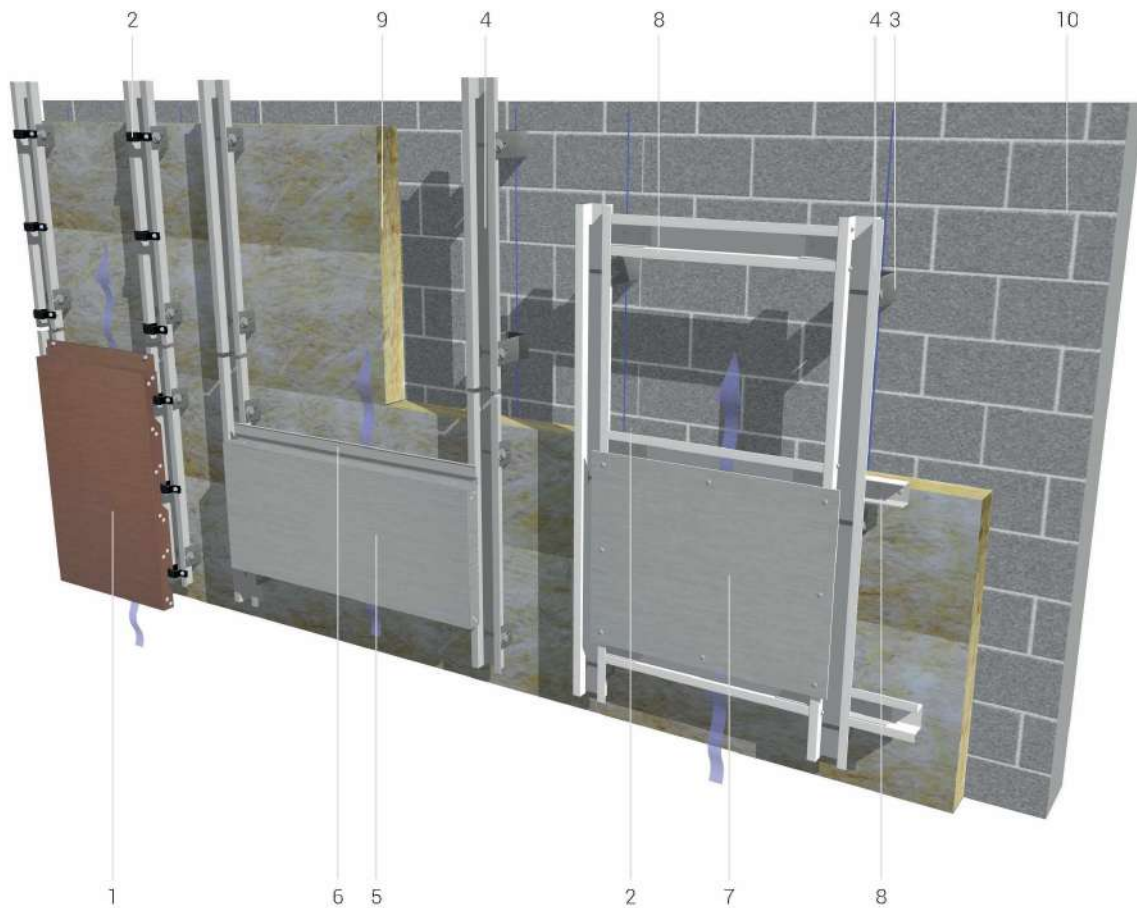

- 1. **elZinc®** hung composite cassette panel
- 2. Hung panel support with anti-vibration sleeve
- 3. Adjustable wall bracket common to all systems
- 4. Top hat aluminium mullion common to all systems
- 5. **elZinc®** tongue and groove composite cassette panel

- 6. Aluminium tongue profile
- 7. **elZinc®** riveted composite material
- 8. Mullion-transome bracket
- 9. Insulation between mullions
- 10. Structural support

Cladding zones for the different systems

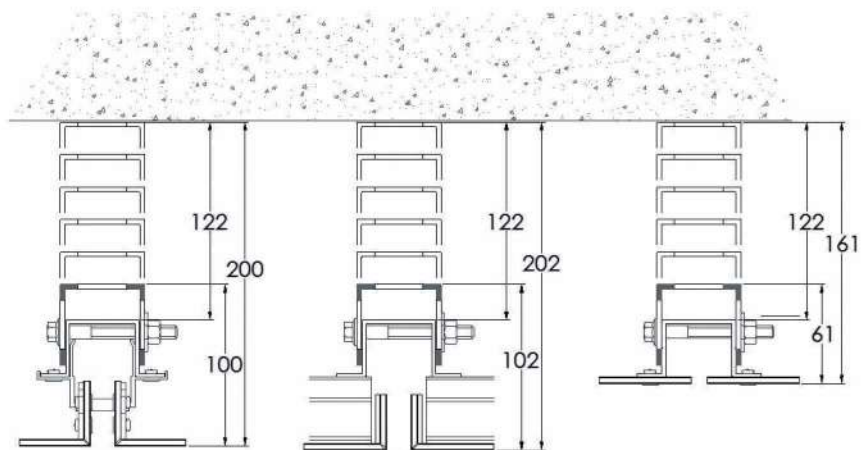

Details:

Air gap:

20mm minimum, some countries require more, usually up to 40mm (eg. residential projects in UK require 38mm). The riveted system's transoms limit the insulation depth to $\approx 100\text{mm}$ (with a 20mm air gap).

Metal rails (mullions):

Extruded aluminium.

Wall brackets:

Wall brackets are adjustable. A range of bracket depths allows for different insulation thicknesses and structure unevenness. A thermal break can be inserted between the bracket and the wall if required.

6. Rainwater systems







Introduction

Zinc rainwater systems collect rainwater from the eaves of the roof and channel it to the ground rainwater management system.

Having a long history, over the decades national and regional variations have developed producing different designs, which likewise have to conform to varying national and regional codes of practice. Rainwater goods made from **elZinc®** are available that can satisfy these variations – read about them in the following sections.

Rainwater systems are dividing into two types:

- Eaves gutters rainwater systems
- Parapet and internal gutters



Eaves gutters rainwater systems

Key points

- **Tried and tested systems** used for generations
- **Does not deteriorate** due to UV radiation
- **Attractive designs** in half round, box section and cornice styles
- Available in elZinc® Natural, elZinc Slate®, elZinc Graphite® and elZinc Crystal®
- **Very long lasting** and maintenance free
- **Fully recyclable**

Basic system information

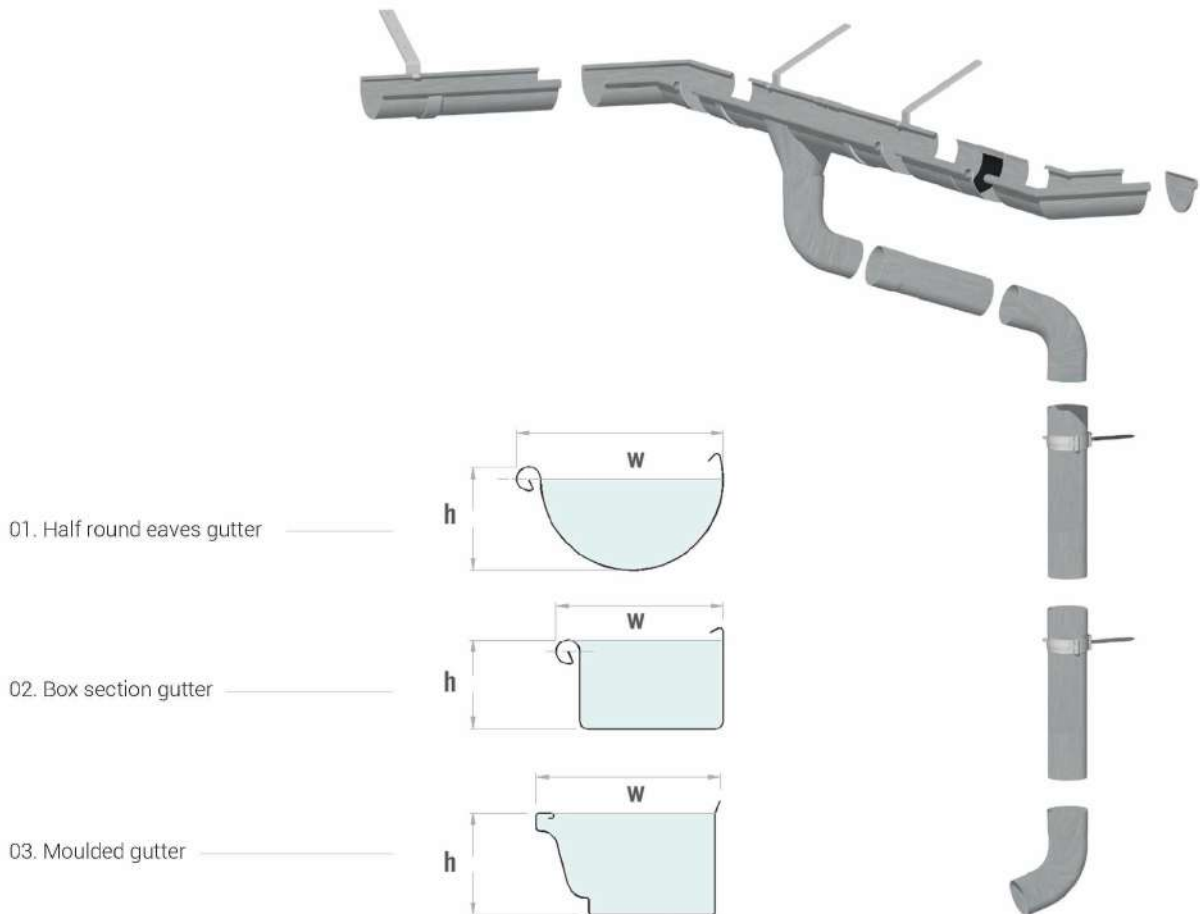

Installation

Eaves gutters should be installed to a slight fall to aid their self-cleaning. Ideally 3 – 5mm / m but at least 1mm / m. This also gives them added flow capacity.

Thermal expansion and contraction

Gutters are installed to allow for thermal movement and the entire system is designed taking this into account. The gutter brackets allow the gutter to slide over them and expansion joints are placed every 15m maximum (7,5m maximum from corners or running outlets) to keep expansion within limits.

HANGING GUTTER AND ASSOCIATED DOWNPIPE SIZES					
Gutter Girth	Width (w), depth (h) in mm, section (cm ²)			Corresponding downpipe	
	Half round	Box section	Cornice	Round	Square
200	96, 40, 25	86, 42, 29	-	60	60 x 60
250	123, 53, 43	103, 55, 47	-	80	80 x 80
280	145, 63, 63	-	-	80 / 87	-
333	173, 77, 92	140, 75, 90	150, 98, 110	100	95 x 95
400	214, 96, 145	172, 90, 135	-	120	120 x 120
500	272, 125, 245	222, 110, 220	-	120 / 150	120 x 120

Eaves gutters rainwater systems

Supports

Gutter brackets that conform to DIN norms should be fixed at centers varying from 700mm to 900mm according to the expected snow loads, or can be fixed to line up with standing seam centers (more expensive than the former but generally it looks much better).

Two main types of bracket exist:

- Roof fitted
- Fascia fitted

Roof fitted brackets must be rebated into the substrate to fit flush with the surface. They should be securely fitted, which means they should be either nailed or screw fixed through to the rafters (which in turn means they will not line up with standing seam centers) or alternatively fitted to an eaves board made of solid softwood which allows the brackets to be fixed independently of rafter positions and thus to line up with seam centers – see drawings.

Cold climates

In cold climates, snow retention systems should be installed to prevent snow slipping onto the gutters from the roof. This can quickly overload the brackets and damage the gutter – local regulations may apply. If this is not possible for any reason, then the gutter's front edge should not be higher than the projected line of the roof.

Connections

Gutters lengths are joined end to end and connected to corners and expansion joints using soft soldered joints.

Outlets

- **Universal outlets.** There are various standard dimensions to provide a number of gutter / outlet combinations. The outlet is hooked around the gutter and is free to move so it does not limit thermal movement.

- **Running (spigot) outlets** are soldered to the gutter, so they do limit thermal movement and therefore an expansion joint must be placed a maximum of 7,5m from them.

It is good practice to provide an outlet next to internal angles to deal with the extra flow at that point from the valley gutter. Depending on the size of the roof, a corner hopper may be beneficial.

Downpipe assembly

Downpipes are fixed to the wall at centers not exceeding 3m using downpipe brackets. These are positioned at the top of each pipe, just below the sleeved end to end downpipe joint (which is slightly wider) and therefore cannot slip through the bracket. The downpipes should be lapped 50mm within each sleeved joint. The pipes should be fixed at least 20mm away from the wall.

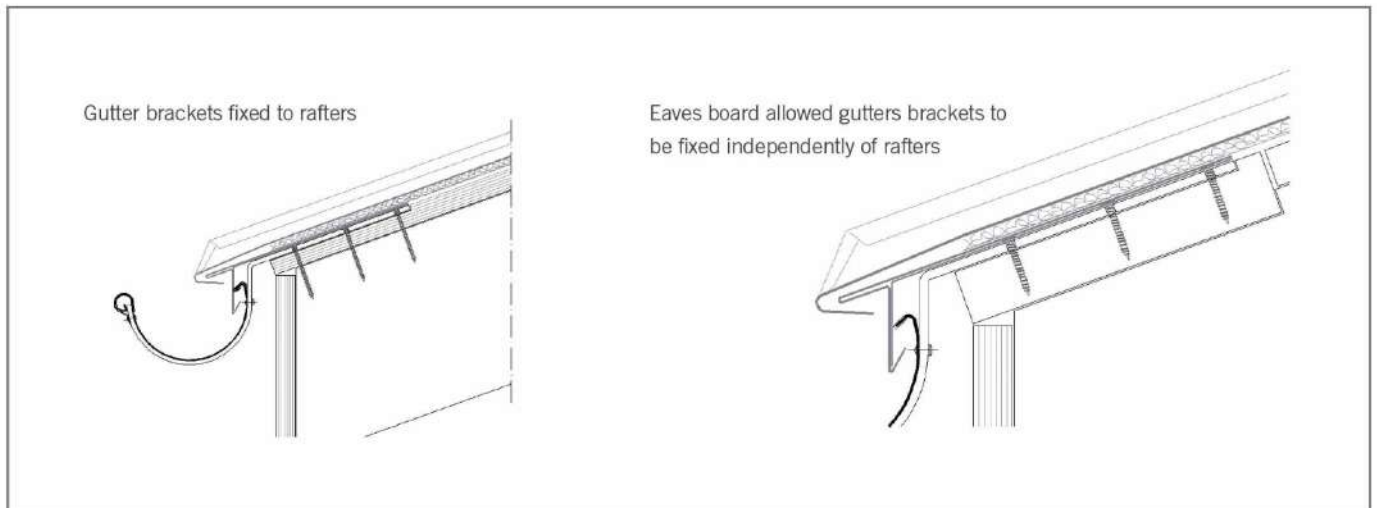

Gutter sizing

The drainage capacity of the rainwater system is affected by the capacity of the gutter to carry rainwater to the outlet, and the capacity of the outlet and rain water pipe to drain that water. In normalized eaves gutter systems, outlets, downpipes and gutters are designed to create free discharge conditions, meaning that only the gutter run needs to be calculated.

Using EN 12056-3, which assumes free discharge conditions, the following tables giving gutter flow capacity and the effective roof area able to be drained by a gutter run is shown. These figures assume nominally level gutters and no wind effect on the effective catchment area.

Half round gutter capacity table

Gutter run	250 mm girth			333 mm girth			400 mm girth			500 mm girth		
	Q	Effective catchment area in r= l/s ha		Q	Effective catchment area in r= l/s ha		Q	Effective catchment area in r= l/s ha		Q	Effective catchment area in r= l/s ha	
	[l/s]	300	400	[l/s]	300	400	[l/s]	300	400	[l/s]	300	400
<5	1,07	36 m ²	27 m ²	2,64	88 m ²	66 m ²	4,63	154 m ²	116 m ²	8,66	289 m ²	217 m ²
7,5	1,02	35 m ²	26 m ²	2,54	84 m ²	63 m ²	4,48	149 m ²	112 m ²	8,59	286 m ²	214 m ²
10	0,97	32 m ²	24 m ²	2,45	82 m ²	61 m ²	4,35	145 m ²	109 m ²	8,35	278 m ²	209 m ²
15	0,88	29 m ²	22 m ²	2,28	76 m ²	57 m ²	4,10	137 m ²	103 m ²	7,97	266 m ²	199 m ²
20	0,80	27 m ²	20 m ²	2,12	71 m ²	53 m ²	3,87	129 m ²	97 m ²	7,60	253 m ²	190 m ²

Box section gutter capacity table

Gutter run	250 mm girth			333 mm girth			400 mm girth			500 mm girth		
	Q	Effective catchment area in r= l/s ha		Q	Effective catchment area in r= l/s ha		Q	Effective catchment area in r= l/s ha		Q	Effective catchment area in r= l/s ha	
	[l/s]	300	400	[l/s]	300	400	[l/s]	300	400	[l/s]	300	400
<5	1,02	34 m ²	26 m ²	2,38	79 m ²	59 m ²	3,96	132 m ²	99 m ²	7,23	241 m ²	181 m ²
7,5	0,97	32 m ²	24 m ²	2,28	76 m ²	56 m ²	3,83	127 m ²	95 m ²	7,02	234 m ²	175 m ²
10	0,82	30 m ²	23 m ²	2,18	73 m ²	55 m ²	3,63	121 m ²	91 m ²	6,82	227 m ²	172 m ²
15	0,82	28 m ²	20 m ²	2,01	67 m ²	50 m ²	3,44	115 m ²	86 m ²	6,43	214 m ²	161 m ²
20	0,74	25 m ²	19 m ²	1,85	62 m ²	46 m ²	3,21	107 m ²	80 m ²	6,07	202 m ²	152 m ²

'r' is rainfall in l/s ha. 300l/s ha is equivalent to 108mm/h, 400l/s ha is 144mm/h. For other rainfall intensities, please contact **elZinc®**.

It should be noted that for each corner within the run with a change in direction greater than 10°, both the discharge capacity of the gutter and the roof area it can drain must be reduced by 15%. Further reductions are needed if the outlet is fitted with a leaf guard.

For more information on the dimensioning of hanging gutters, please consult our technical department.

Parapet and internal gutters

Key points

- **Long lasting** and maintenance free
- **Lightweight** and sustainable
- Available in elZinc® Natural, elZinc Slate®, elZinc Graphite® and elZinc Crystal®
- **Matches the elZinc® roof**
- Must be **carefully designed** and installed

Basic system information

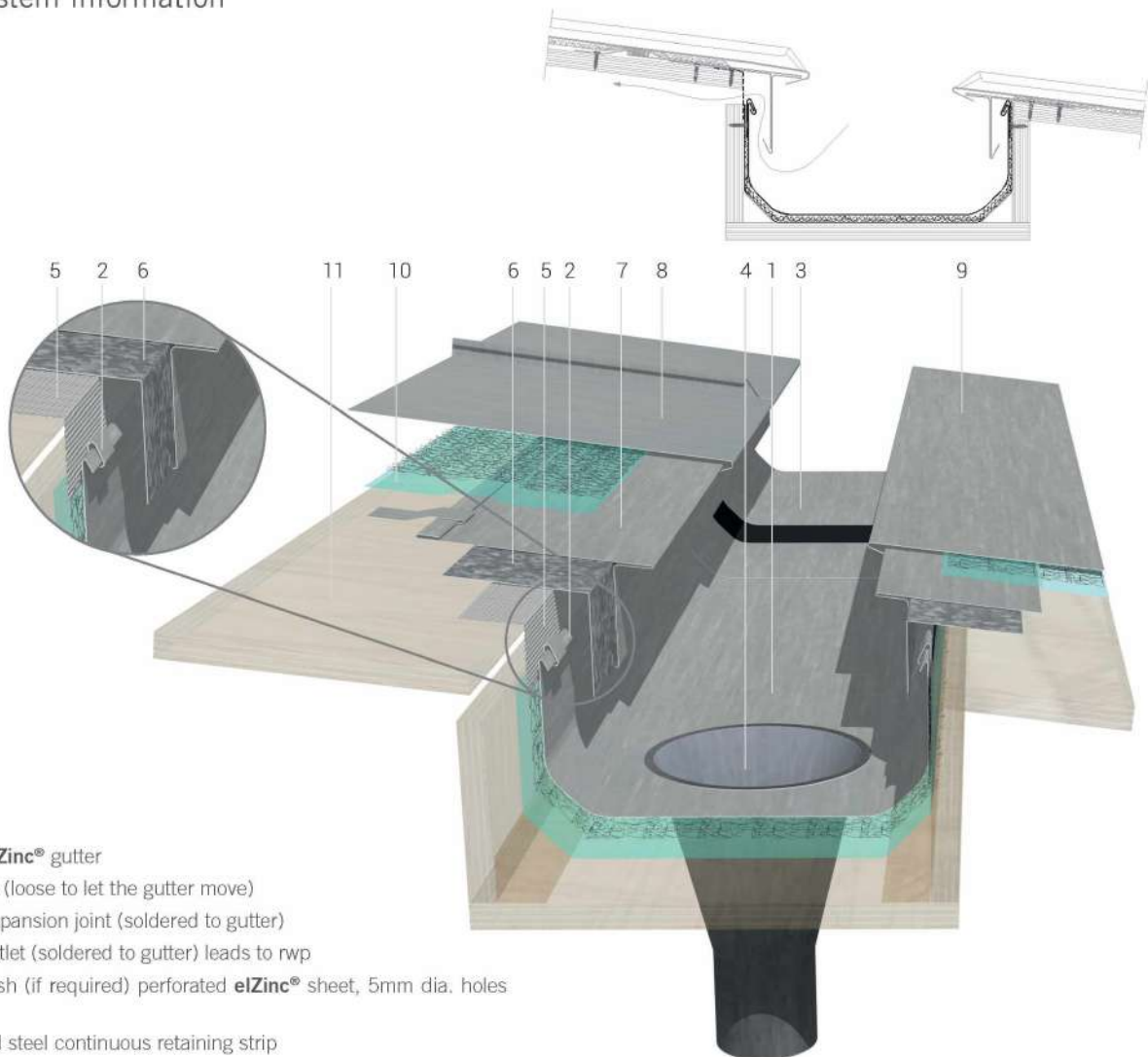

1. Internal **elZinc®** gutter
2. Gutter clip (loose to let the gutter move)
3. 'T-Pren' expansion joint (soldered to gutter)
4. Conical outlet (soldered to gutter) leads to rwp
5. Insect mesh (if required) perforated **elZinc®** sheet, 5mm dia. holes shown
6. Galvanised steel continuous retaining strip
7. **elZinc®** 'T' plate (with back fold when roof pitched below 15°)
8. Standing seam trays
9. Cladding below gutter
10. Underlay and membrane (if required – mat and breather shown)
11. Substrate (varies according to roof design and country)

Installation

Internal gutters are folded to shape either on site or in the workshop. The gutter sections are joined end to end with soft soldered joints. They should be laid to a fall if possible to promote self-cleaning and increase flow capacity.

Thermal expansion

Thermal expansion and contraction is accommodated for by inserting 'T'-Pren type expansion joints within the gutter run, and ensuring that the gutter is loosely clipped along its sides so it can move more freely.

Location of expansion joints		
Gutter girth (mm)	Exp. Jt. centres (m)	Max. distance from outlet, corners etc. (m)
≤500	<8	<4
>500	<15	<7,5

Outlets and overflows

Due to the consequences of internal gutters overflowing being much more serious than in the case of hung gutters, at least two outlets should be used to drain each run, each able to take the design flow if the other blocks. If this is not possible, then an overflow should be incorporated to prevent flooding of the gutter in case of outlet blockage. Conical outlets are much more effective at draining gutters – their top width should be $\frac{3}{4}$ that of the gutter sole for maximum effectiveness.

Snow and ice protection

In cold climates, thermostatically controlled trace heating cables should be installed in gutters where there is a risk of snow and ice build-up blocking the water flow. In addition, snow retention systems should be installed to prevent snow from the roof from sliding into the gutter and blocking it – local regulations may apply.

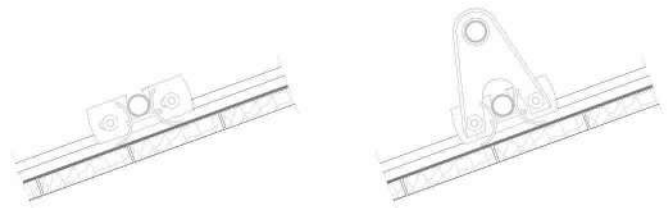

Additional overflow protection

Buildings which require very high protection from water ingress may need a second gutter under the zinc gutter, to act as a back-up system. This secondary gutter must drain into an outlet into which the zinc outlet sits.

Flow capacity

Internal gutter capacity is also calculated using EN 12056-3. However, guidance on calculating the required capacity of the system is beyond the scope of this media. Please contact **elZinc®** for assistance in this regard if required.

7. Services

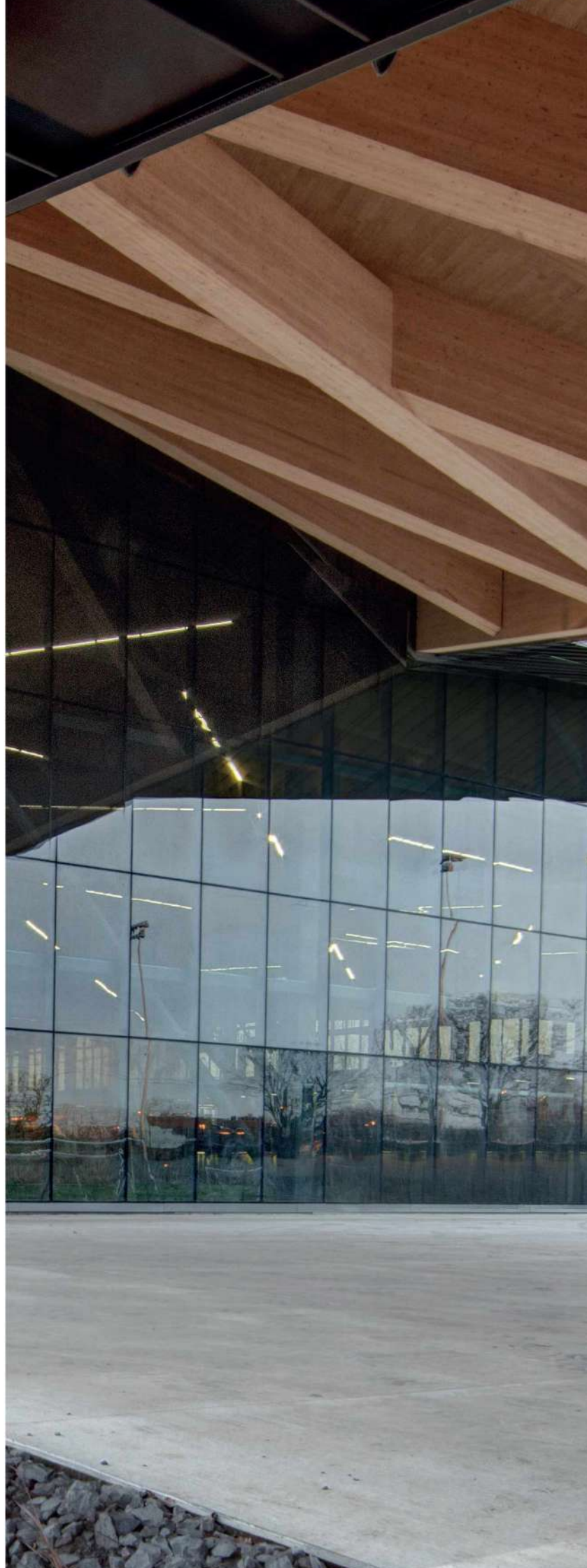



Technical and commercial assistance

One priority: Your satisfaction

Your project not only requires the best product but also personalized technical advice. To the end, **elZinc®** has made available a wide network of technical advisers.

a) Comprehensive project consultation service

- Selection of suitable products and system. We will help you to choose the product/system combination that is best suited to your architectural vision
- Ideas on the layout design, especially important on façades, with the aid of 3D rendered models. Advice, tips and ideas in order to reflect the message that you want the design to communicate through the 'face' of the façade
- Cladding build-up design, in order to ensure an effective building envelope
- Detail development. We help you choose the details that best suit the project
- Specification writing, in order to ensure that what has been designed will be faithfully carried out on-site
- A cost estimate, including the installation and supporting materials, for budgetary purposes
- A list of specialist hard metal roofing contractors in your area in order to ensure the material is in good hands on the building site

To ensure a smooth process from start to finish, we also make our experience available to the Project Manager, Main Contractor and/or the Installer, advising on:

- Cladding component manufacturing
- Setting out the layout design
- Correct handling and care of the material on site
- Correct forming of details

b) Technical training days aimed at architects

elZinc® organizes technical training days and presentations at Colleges of Architecture and architectural offices covering available finishes, surface weathering, system selection, design, and installation of zinc cladding, including maintenance and approximate installed prices.

c) Technical training days for installers

elZinc® also offers training courses covering the various techniques and methods **elZinc®** recommends for its zinc-titanium cladding.

- Theoretical guidance
- Various levels of practical training courses carried out at the Installers workshop
- On site support

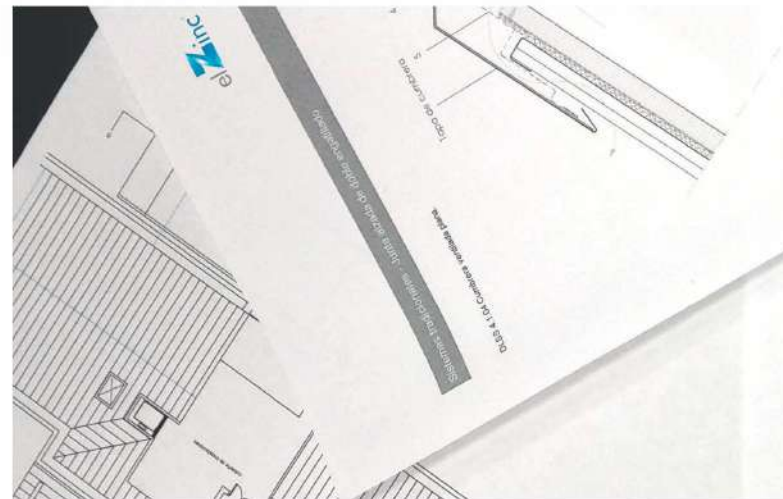

Our top priority is our client's interests and our service quality!



d) Documentation.

- **elZinc BIM Objects:** To help you to design your elZinc facade or roof project in **BIM**, we have developed a series of BIM objects with the most representative installation systems available on the BIMObject® platform and on our webpage. Easy to use, our objects contain detailed technical information and high quality textures of all our finishes. In addition, if you work in Autodesk Revit you can visualize your projects even more realistically by using our pattern-based surfaces.

- **elZinc 3D Models:** In addition to the more than 500 Architectural Details available in pdf and autocad for facades and roofs in zinc available to you from elZinc, you can check out our 3D Models.

- Technical booklet
- AutoCad details Library
- 3D models
- Specifications Templates
- Product quality certificates (of zinc, finishes EPD etc..)
- Maintenance requirements

e) Wide international commercial network.

Apart from its internal customer's service, **elZinc®** also has an extensive external collaborators network. From its origins, **elZinc®** has been building an international network of professionals, which includes agents and distributors in more than 45 countries. They will advise you on the selection, purchase and installation of its **elZinc®** products.



DLSS 6.1.01 – Vented abutment (under window).

All our documentation is available on our webpage
www.elzinc.es



Appendix

Roof pitch conversion table, degrees to %.

Degrees	%	Imperial	Degrees	%	Imperial	Degrees	%	Imperial	Degrees	%	Imperial
1	2	0,21	26	49	5,85	51	123	14,82	76	401	48,13
2	3	0,42	27	51	6,11	52	128	15,36	77	433	51,98
3	5	0,63	28	53	6,38	53	133	15,92	78	470	56,46
4	7	0,84	29	55	6,65	54	138	16,52	79	514	61,73
5	9	1,05	30	58	6,93	55	143	17,14	80	567	68,06
6	11	1,26	31	60	7,21	56	148	17,79	81	631	75,77
7	12	1,47	32	62	7,50	57	154	18,48	82	712	85,38
8	14	1,69	33	65	7,79	58	160	19,20	83	814	97,73
9	16	1,90	34	67	8,09	59	166	19,97	84	951	114,17
10	18	2,12	35	70	8,40	60	173	20,78	85	1143	137,16
11	19	2,33	36	73	8,72	61	180	21,65	86	1430	171,61
12	21	2,55	37	75	9,04	62	188	22,57	87	1908	228,97
13	23	2,77	38	78	9,38	63	196	23,55	88	2864	343,64
14	25	2,99	39	81	9,72	64	205	24,60	89	5729	687,48
15	27	3,22	40	84	10,07	65	214	25,73	90	Infinite	
16	29	3,44	41	87	10,43	66	225	26,95			
17	31	3,67	42	90	10,80	67	236	28,27			
18	32	3,90	43	93	11,19	68	248	29,70			
19	34	4,13	44	97	11,59	69	261	31,26			
20	36	4,37	45	100	12,00	70	275	32,97			
21	38	4,61	46	104	12,43	71	290	34,85			
22	40	4,85	47	107	12,87	72	308	36,93			
23	42	5,09	48	111	13,33	73	327	39,25			
24	45	5,34	49	115	13,80	74	349	41,85			
25	47	5,60	50	119	14,30	75	373	44,78			

Vapour resistance		Vapour transmission		
sd value (UK)	MNs/g	g/(MNs)	US Perm	Metric Perm
0,02	0,1	10	174,8	115,2
0,04	0,2	5	87,4	57,60
1	5	0,2	3,50	2,30
20	100	0,01	0,175	0,115
100	500	0,002	0,035	0,023
400	2000	0,0005	0,009	0,006
800	4000	0,0003	0,004	0,003

Weight to area conversion table, flat sheet.

Thickness (mm)	kgs/m ²	kgs/100m ²	kgs/1000m ²	m ³ /kg	m ² /t
0,7	5,04	504	5040	0,198	198,4
0,8	5,76	576	5760	0,174	173,6
1	7,2	720	7200	0,139	138,9
1,2	8,64	864	8640	0,116	115,7
1,5	10,8	1080	10800	0,093	92,6

Multifunctional room, Lucinges, France
AER Architectes.





Asturiana de Laminados, S.A. has developed instructions and recommendations – published on this website and on other printed documents – with the aim of providing a better service for its customers. It is generic information for standard installation of elZinc® products in a European climate.

This information must not substitute the considerations and requirements that, in each project, architects, designers and consultants may offer.

Asturiana de Laminados, S.A. does not accept any responsibility therefore for any damage incurred to third parties, directly or indirectly by the misapplication, misinterpretation or general incorrect use of the information contained in all its tools and documents, exonerating itself from all and any responsibility deriving from this document, within the legal framework established and applicable in each case.

We remind readers that Asturiana de Laminados, S.A. provides an advisory service to assist in the interpretation and use of this information should any doubts arise in this regards.

Asturiana de Laminados, S.A.
Polígono Industrial de Villallana,
Parcela 1
33695 Pola de Lena - Spain
Tel (0034) 98 410 60 00
Fax (0034) 985 49 32 02

October 2019
www.elzinc.es
elzinc@aslazinc.com