



elZinc

DETAILS,
PROCESSING
AND INSTALLATION

elZinc
DETAILS,
PROCESSING AND
INSTALLATION

Note:

This brochure is intended to support architects, planners and engineers, along with handlers and installers in all matters relating to handling, storage and transport as well as processing and installation of elZinc® titanium zinc.

elZinc is a material with a particularly high level of quality and outstanding features and was developed and produced to meet the standard requirements for a high-quality sheet for building applications in accordance with standards, technical rules and trade rules.

All the important features and advice on use and on processing of elZinc strips and sheets are dealt with.

However, the applicability of all advice and information for each actual case of application should be carefully checked, since all circumstances and local conditions must be taken into account as a matter of principle. The issuer cannot therefore accept any liability for completeness, correctness or omissions.

ASTURIANA DE LAMINADOS is committed to quality as a supplier of titanium zinc for roofs and walls, as well as for building components, across many regions. ASTURIANA DE LAMINADOS supplies the international markets under the name of elZinc®.

All elZinc® products comply with the relevant standards. The raw materials and alloying components used in production are subject to the strictest reception controls and are regularly monitored by external bodies.

This handbook has been created in an effort to provide all customers and partners of elZinc® with comprehensive, application-oriented and objective technical information. The data have been very carefully compiled and represent state-of-the-art technology.

Advice is given on what measures must be adhered to for transport and storage and what combinations of materials or installation situations are preferable; clear advice is also given as to which applications or conditions may lead to damage. These are to be avoided in terms of design and planning, as well as during processing.

The information is based on the comprehensive experience of elZinc® as a renowned manufacturer which has been supporting and advising its customers and partners in all matters relating to material properties and applications.

The processors and tradespeople can find detailed information for handling and processing the material in an appropriate way, as well as dimensions, sizing and installation. Planners and architects will be able to use the information and proposals in the text for their day-to-day work and the information can of course be supplemented as required and adapted to the conditions relating to each structure.

elZinc® would be happy if this handbook became an important tool to help all construction professionals and was distributed as widely as possible.



CONTENTS

01. elZinc®: TITANIUM ZINC WITH SPECIAL QUALITY	10
01.1. Quality assurance and strict production monitoring	11
01.2. Alloy and properties according to EN 988	13
01.3. Fire behavior and fire resistance	15
01.4. Lightning protection	16
01.5. Environment and sustainability; recycling	17
02. CONTACT CORROSION, CONSTRUCTION ELEMENTS AND COMPONENTS MADE OF DIFFERENT METAL	18
02.1. Contact corrosion, assembly of different metals	19
02.2. Rainwater outflow, flow regulation	21
03. elZinc® TITANIUM ZINC	22
03.1. Suppliable formats	23
03.1.1. Panels:	23
03.1.2. Zinc strip (coils)	24
04. elZinc® TITANIUM ZINC FOR ROOF CLADDING	28
04.1. Roof systems - an overview	29
04.1.1. "Cold roof": Roof structure with back-ventilation:	29
04.1.2. "Warm roof": roof structure without rear ventilation:	30
04.1.3. "Compact roof": roof structure without rear ventilation on vapour barrier layer:	31
04.1.4. Roof pitch: in the case of standing seam roofs	33
04.1.5. Rear ventilation: Design of the air intake and outflow	25
04.1.6. Length expansion, expansion allowance	37
04.1.7. Minimum sheet thickness corresponding to standards and general rules	39
04.2. Standing seam roofs	40
04.2.1. Double lock standing seam covering	40
04.2.2. Single lock standing seam system	42
04.2.3. Clip point areas: Fixed clips and sliding clips	43
04.2.4. End lap forms in standing seam roofs	47
04.2.5. Substructure	50
04.3. Roll cap roofs	53
04.3.1. Roof structure	53
04.3.2. Belgian roll cap system	54
04.3.3. German roll cap system	55
04.3.4. Combination of roll cap systems	56

04.3.5. Distribution and width of the bays in the case of roll cap systems	56
04.3.6. Laying battened roofs	57
04.4. Lozenge roofs	61
04.5. Green roofs	66
04.6. Design of the ridge	68
04.7. Batten design	70
04.8. Design of the eaves	71
04.9. Design of the verge	73
04.10. Connection to vertical construction elements, ridge-end wall connection	75
04.11. Lateral wall connection	75
04.12. Valley designs in seamed and battened roofs	77
04.12.1. Recessed valleys (valley pitch up to 7° [12%])	78
04.12.2. Custom solution: Replacement of the valley with custom bays in the case of valley pitch from approx. 5° [9%]:	79
04.12.3. Valleys with a double valley seam (valley pitch 7° [12%])	80
04.12.4. Valleys with a single valley seam with additional seam (valley pitch 10° [18%]) or without additional seam (valley pitch 25° [47%])	81
05. elZinc®-TITANIUM ZINC FOR FAÇADES AND WALL CLADDINGS	82
05.1. Design types	83
05.1.1. Manually fitted claddings and façades	83
05.1.2. Finishes, appearance, evenness	84
05.1.3. Structural stability, fire safety, thermal insulation	85
05.1.4. Substructure and ventilation	86
05.1.5. Instructions for execution	91
05.2. Prefabricated facade elements	97
06. SURROUNDS, CAPPINGS AND FLASHING	100
06.1. Basic instructions	101
06.2. Fall	106
06.3. Separating layers	107
06.4. Edge design, drip ledge	107
06.5. Borders	109
06.6. Pipe diameters, aerial attachments	110
06.7. Gluing below the water level with bituminous sealant	112
06.7.1. Separation of titanium zinc flashing and bituminous roof skin	113
06.8. Expansion absorbers (dilatations)	114
06.9. Substructure, profiles for borders and flashings	116
06.9.1. Profiles	116
06.9.2. Separation layer, protecting coating	117

07. ROOF DRAINAGE MADE OF TITANIUM ZINC	118
07.1. Gutters	119
07.1.1. Types of gutters made of titanium zinc	119
07.1.2. Shapes and dimensions of roof gutters	120
07.1.3. Installation of gutters, fall	122
07.1.4. Connecting gutters	123
07.1.5. Connection to the roof cover, eaves design	124
07.1.6. Gutter brackets	125
07.2. Special features of internal gutters	127
07.2.1. Ventilation, heat insulation of valley gutters	127
07.3. Snow guard, snow-slip protection	128
07.4. Accessories for gutters; terms, short explanations	129
07.5. Titanium zinc downpipes	130
07.5.1. Design types	130
07.5.2. Installation instructions	130
07.5.3. Accessories for rain downpipes; terms, short explanation	131
07.6. Dimensioning roof drainage systems	133
07.6.1. General notes	133
07.6.2. Dimensioning of roof drains according to EN 12056- 3 and DIN 1986-100	133
07.6.3. Instructions on dimensioning	134
08. PROCESSING ELZINC® TITANIUM ZINC SHEET AND ELZINC® TITANIUM ZINC COMPONENTS	138
08.1. Basic information on fastening and connecting	139
08.2. Gluing titanium zinc with adhesive compound	140
08.3. Soldering (soft soldering)	141
08.4. Welding	143
08.5. Screws, rivets	144
08.6. Staples, nails	145
09. SURFACE FINISHES OF ELZINC® TITANIUM ZINC	146
09.1. Different types of component – different exposures	147
09.2. Different locations – different types of air	148
09.3. Different compass directions – different weathering times	149
10. GENERAL REQUIREMENTS	150

ASTURIANA DE LAMINADOS, S.A.

With its headquarters in Asturias (Spain), elZinc® has been producing strips and sheets made of titanium zinc, along with zinc anodes for electroplating since 2009.

ASTURIANA DE LAMINADOS is now one of the most important producers of titanium zinc (EN 988). Under the brand name elZinc®, which has been introduced on an international basis, elZinc® supplies its products to more than 30 countries.

elZinc® feels a particular commitment to environmental protection and sustainability. Sustainability and quality are clearly laid down as corporate aims and are converted into actual day-to-day practice in regular in-house training sessions.

This means that all stages of production are continuously optimised and monitored in terms of energy use, efficiency of the individual stages of production, conservation of resources and environmental friendliness. A team of managerial staff regularly evaluates production processes, assesses advice from staff and develops strategies for improving quality, along with optimisation of environmental awareness at the same time.

Milestones in the history of ASLA:

- 2006: Foundation of Asturiana de Laminados, SA
- 2007: Start of construction of the first production unit
- 2009: Delivery of the first order of rolled zinc
- June 2011: Delivery of the first order of elZinc® Slate (pre-weathered, light)
- 2011: Start of construction of the second production unit
- 2012: elZinc® is operating on all 5 continents
- 2012: Launching of elZinc Rainbow® range (red, blue, green, brown, gold and black)

SERVICE AND CUSTOMER ORIENTATION: A PROMISE!

Erecting buildings is a complex process which is split into many interconnected subtasks. The roofing must be incorporated into an initial stage of construction of the building. Façade work is often carried out under time pressure for completion at the end of the building work, when very many trades are still however pressing ahead with their work, both on the exterior and internal fittings.

elZinc® with its internationally experienced consultancy team of materials and processing experts, is a partner for the most demanding projects and supports both industrial and trade processors in all technical matters relating to materials or processing.

Choosing the modern material **elZinc®** titanium zinc means you are sure to receive the competent and unbureaucratic support of elZinc® in every phase of the construction task.

Because your success as a processor and installer is our success.





01.
elZinc[®]:
TITANIUM ZINC
WITH SPECIAL
QUALITY

01.1.QUALITY ASSURANCE AND STRICT PRODUCTION MONITORING

eZinc® has introduced a quality management system in accordance with ISO 9001:2008 and monitors all materials used and stages of production in a very detailed way.

Compliance with tight works specifications, which must be fulfilled in addition to the requirements of the standards of each eZinc® coil or eZinc® sheet, is regularly monitored and confirmed by independent inspections.

Each strip or sheet made of eZinc® is therefore provided with a continuous stamp on the surface of the sheet as below.



This means that each sheet, product width 1,000 mm, can be identified at any time by the stamp. With sheet blanks, longitudinal cutting or cross-cutting of sheets it can happen that the continuous stamp is not identifiable on every blank.

Coils or packs of sheets are marked on the packaging as follows:

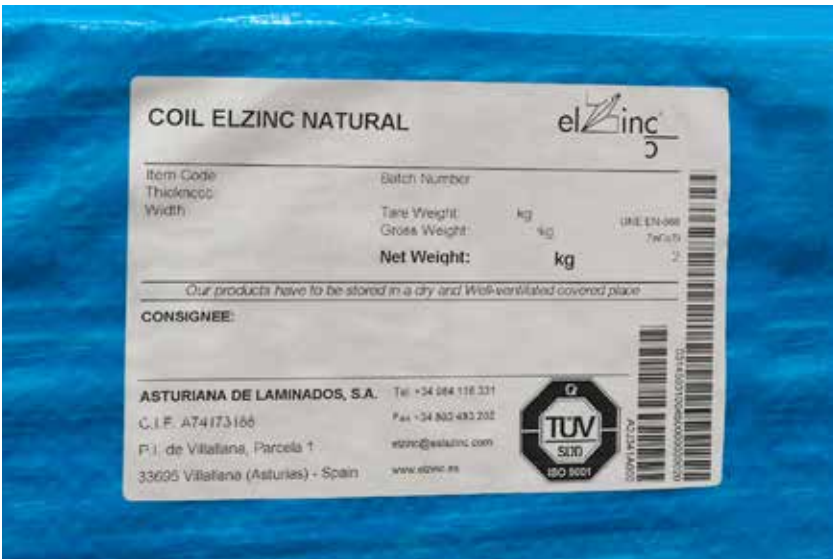

elZinc® is therefore fully recognizable at any time even if packaging has been opened and stickers removed. The stamp can demonstrate, even years later in the event of any doubt about the origin of any components installed on a building (which should in principle be on the top surface of the building component that has been fitted), that the titanium zinc that has been installed is actually elZinc® titanium zinc.

01.2. ALLOY AND PROPERTIES ACCORDING TO EN 988

Naturally, elZinc® titanium zinc meets all the standards' requirements, both for the finished strips and sheets and for the individual alloying components.

elZinc® titanium zinc comes under the **EN 988 standard**, which defines the general requirements for titanium zinc strips and sheets for use in the building industry.

The alloying components are high-grade refined zinc of the highest standardized level of purity Zn 99.995 according to EN 1179, with precisely defined additions of copper and titanium. Further components, such as aluminium and other trace elements, are accurately limited and the purity of the alloy is extremely precisely monitored by regular controls.

elZinc® titanium zinc consists primarily of zinc with small amounts of copper and titanium; this is precisely defined for the proprietary elZinc® alloy and is precisely adapted to the elZinc® rolling process.

PRODUCT REQUIREMENTS	ELZINC TITANIUM ZINC	EN 988 STANDARD
CHEMICAL COMPOSITION		
Zinc	Zn 99,995 (Z1 as per DIN EN 1179)	Zn 99,995 (Z1 as per DIN EN 1179)
Copper	0.08 - 0.2%	0.08 - 1.0%
Titanium	0.07 - 0.12%	0.06 - 0.2%
Aluminium	max. 0.015%	max. 0.015%
DIMENSIONS		
Thickness of sheets/coils	± 0.02 mm	± 0.03 mm
Width of sheets/coils	+1/-0 mm	+ 2 / -0 mm
Length of sheets	+ 2 / -0 mm	+ 10 / -0 mm
Straightness	max. 1,0 mm/m	max. 1,5 mm/m
Flatness	max. 2mm	max.2 mm

PRODUCT REQUIREMENTS	ELZINC TITANIUM ZINC	EN 988 STANDARD
MECHANICAL AND TECHNICAL PROPERTIES		
Yield strength elasticity (Rp 0,2)	min. 110 N/mm ²	min. 100 N/mm ²
Tensile strength (Rm)	min. 150 N/mm ²	min. 150 N/mm ²
Breaking elongation (A50)	min. 40 %	min. 35%
Vickers hardness (HV3)	min. 45	-
Folding test	No cracks at the edge of fold	No cracks at the edge of fold
Bending back after folding test	No cracks	-
Erichsen test	min. 7,5 mm	-
Remaining stretch in creeping behaviour test (Rp0,1)	max. 0,1%	max. 0,1%

CHARACTERISTIC	UNIT	VALUE
Density	kg/dm ³	7,2
Coefficient of linear expansion, parallel to the direction of rolling	m/(m K)	22 x 10 ⁻⁶
Melting point	°C	approx. 420
Recrystallisation temperature	°C	min. 300
Thermal conductivity	W/(m K)	110
Electrical conductivity	mS/m	17

Table 1: Mechanical and technological data elZinc® titanium zinc

elZinc® titanium zinc has been optimized for use in building applications. Prerequisites for this are the rolling process, which is precisely tailored to the elZinc® alloy, and accurate temperature control during manufacture.

This means consistent quality and maintenance of all characteristics.

elZinc® titanium zinc features

- very good workability irrespective of the direction of rolling
- high creep strength (creep strain limit)
- low cold brittleness
- high recrystallisation threshold, i.e. no grain growth until 300°C; this is crucial for soldering

elZinc® titanium zinc has been especially developed for construction applications - precisely in fact.

01.3. FIRE BEHAVIOUR AND FIRE RESISTANCE

elZinc® –titanium zinc is metallic and consists exclusively of metallic alloys. elZinc® titanium zinc is therefore non-flammable and makes no contribution in the event of a fire to the spread or intensifying of the fire.

A roof area or wall surface made of elZinc® titanium zinc is therefore resistant on the basis of the material elZinc® titanium zinc to sparks and radiant heat.

The fire resistance for a component (e.g. a wall construction) depends however on the interaction of all layers and components, in other words including the substructure etc.

The achievable fire resistance class is therefore predominantly determined by the fire properties of the substructure. With corresponding formwork and insulating layers, very high fire resistance periods have been recorded, which can play an important part for instance in fire escapes and emergency exits.

01.4. LIGHTNING PROTECTION

elZinc® surfaces which are connected by folding, as roof or facade surfaces, are classed as a 2D lightning conductors, because the linear seams fulfil the requirements of the minimum conducting surface cross section very well.

This connection with the conducting surface is even sufficiently effective if for example additional sealing tapes (seam seals) have been inserted into the seams in very slightly pitched surfaces because these sealing tapes (as well as the alternative seam gel) are only applied to the underneath of the seam before folding and the sealing of the seam results in a conductive connection.

Earthing is carried out via separate discharges, which are connected to the seams by special clamps. When whole roof surfaces are to act as lightning conductors, all metallic components must be connected together conductively. Connections which are not folded or soldered may need to be connected conductively by means of clamps.

Large non-metallic openings in the roof, like for example roof lights or cupolas, are secured with additional lightning rods, which are connected to a separate discharge or even to the roof surface.

01.5. ENVIRONMENT AND SUSTAINABILITY; RECYCLING

Zinc is a natural element which is found throughout the earth's crust in plentiful supply. Therefore elZinc® titanium zinc is completely environmentally-sustainable.

elZinc® titanium zinc strip and sheet is manufactured according to state of the art ecological factors. Energy-saving is a major feature both during the smelting and casting of the alloy and in the rolling process.

elZinc® feels a particular commitment to environmental protection and sustainability. Therefore all production steps are continually optimized and monitored with respect to energy consumption, efficiency of the individual production steps, resource conservation and environmental sustainability. A team of managers regularly evaluates the production process, analyse information from personnel and develops strategies for increasing quality while simultaneously optimizing the environmental philosophy.

elZinc® titanium zinc is completely recyclable. Both sections and remainders from the processing or installation as well as the sheet metal and construction elements themselves are completely re-usable even if removed from service after a long period in use.

A close-up photograph of a metal structure, possibly a window frame or door hinge, showing two different metal components in contact. The background is a light, neutral color, and the metal parts are dark and metallic. The text is overlaid on the left side of the image.

02.

2. CONTACT
CORROSION,
CONSTRUCTION
ELEMENTS AND
COMPONENTS
MADE OF
DIFFERENT METAL

02.1. CONTACT CORROSION, ASSEMBLY OF DIFFERENT METALS

Damage through electrochemical reaction may occur if titanium zinc components come into contact with copper or unprotected (not galvanized) steel.

In corresponding conditions all metals give off metal ions and energy. Prerequisite is an electrolyte (water, humidity), which can absorb the metal ions and the energy-carrying electrons).

The different metals give off different amounts of electrons, others however have a deficit of electrons. This means the different metals have different “electrochemical” potentials. Different potentials, direct contact and the presence of an electrolyte create a contact element and therefore material destruction.

Whether the damage is significant depends on the potential differences of the metals in contact. The danger of contact corrosion applies particularly for metals which lie far apart in the voltage series and whose potential difference is greater than approx. 400 mV.

The following table shows which metals can be used safely in assemblies with titanium zinc. Based on years of experience and on a wide range of analyses the material combinations marked in Table 2 with a “+” can be viewed as non-critical in normal atmospheres (rural, urban, “normal” industrial atmospheres).

The observation of the metal pairings is always based on the observed material, in other words, the table below is not “symmetrical”.

OBSERVED MATERIAL	PAIRING MATERIAL							
	Zn	fyzSt	Al	BauSt	StGuss	Pb	Cu	nrSt
elZinc titanium zinc: Zn	+	+	+	(1)	(1)	+	(2)	(1)
hot-galvanized steel: fyzSt	+	+	+	(1)	(1)	1)	(2)	(1)
Aluminium: Al	+	+	+	-	-	-	-	+
Structural steel: BauSt	+	+	+	+	+/-	(3)	(3)	(3)
Cast steel: StGuss	+	+	+	+	+	(3)	(3)	(3)
Lead: Pb	+	+	+	+	(3)	+	+	+
Copper: Cu	+	+	+	+	+	+/-	+	+
Non-rusting steel: nrSt	+	+	+	+	+	+	+	+

Table 2: Admissible metal pairings in direct contact with elZinc® titanium zinc

1) Non-critical in the case of sufficient surface ratio of Zn or fyzSt / pairing material, e.g. attachment of elZinc titanium-zinc sheet by means of non-rusting steel bolts; critical in the case of a (very) small surface ratio of Zn or fyzSt / pairing material, e.g. Galvanized washers with stainless steel bolts.

2) Generally critical, however possible with small surface ratio Cu / Zn or Cu / fyzSt (e.g. copper rivets in elZinc titanium zinc or hot-dip Galvanized steel sheet).

3) Critical in the case of small surface ratio of observed material / pairing material, otherwise non-critical.

The evaluation of whether an assembly of different metals can lead to contact corrosion depends in practice on very many factors and in complex cases. You should **always seek the advice of specialist engineers.**

The straightforward observation of the standard potentials is misleading because the actual potential depends on the medium, particularly because the ratios in the contacts of different metals vary greatly through patination under certain circumstances.

Gaps between components:

The contact joints of a connection should have no gaps in which the electrolyte (more-contaminated rainwater) forms capillary bonds.

While the gap corrosion resulting from such circumstances is totally irrespective of the metal pairing, the effect of potential contact corrosion can actually be intensified by the gap corrosion.

02.2. RAINWATER OUTFLOW, FLOW REGULATION

Copper parts discharge very high levels of copper ions, in other words even “normal rainwater” will trigger the release of copper ions.

Copper ions dissolved in rainwater, for example from a copper roof surface above elZinc® titanium zinc surfaces, can cause damage in the long term if rainwater from copper parts flows onto titanium zinc - even without the copper and titanium zinc coming into direct contact.

Vice versa the arrangement of elZinc® titanium zinc above copper surfaces is absolutely non- critical. It is therefore possible without further measures, for example to locate an elZinc® titanium zinc roof surface above a roof drainage system made of copper parts.

Flow rule:

- Never place copper surfaces above elZinc® titanium zinc (or structural metals) in the water-flow direction;
If this is unavoidable the drip point and the water outflow onto the elZinc® components need additional protection (for example paint coating)
- elZinc® titanium zinc can be placed anywhere above copper surfaces or other structural metals.



03.
elZinc[®]:
TITANIUM ZINC

03.1. SUPPLIABLE FORMATS

Based on its customer-orientated, state-of-the-art production control elZinc® can respond very quickly to customer preferences within its process application limits.

In this case there is differentiation between standard formats, which are immediately available from stock, and custom formats, which are produced to customer specifications and which may incur slight surcharges due to special preferences as to delivery form or packaging.

03.1.1 SHEETS:

Sheets in formats:

- 1000 x 2000 mm

Thickness: 0,65 / 0,7 / 0,8 / 1,0 mm

- 1000 x 3000 mm

Thickness: 0,65 / 0,7 / 0,8 / 1,0 mm

ELZINC SHEETS	WIDTH [mm]	LENGTH [mm]	WEIGHT/PANEL [approx. kg]
0,65	1000	2000	9,36
0,7	1000	2000	10,08
0,8	1000	2000	11,52
1,0	1000	2000	14,40
0,65	1000	3000	14,04
0,7	1000	3000	15,12
0,8	1000	3000	17,28
1,0	1000	3000	21,60

Table 3: elZinc® titanium zinc sheets: natural – standard formats

ELZINC SHEETS	WIDTH [mm]	LENGTH [mm]	WEIGHT/PANEL [approx. kg]
0,65	1000	2000	9,36
0,7	1000	2000	10,08
0,8	1000	2000	11,52
1,0	1000	2000	14,40
0,65	1000	3000	14,04
0,7	1000	3000	15,12
0,8	1000	3000	17,28
1,0	1000	3000	21,60

Table 4: elZinc® titanium zinc sheets: pre-weathered – standard formats

Additional dimensions and designs on request

elZinc® titanium zinc panels are checked for flatness during manufacture. The panels are therefore basically ready for cutting with no further treatment and for industrial or technical processing.

If a particular flatness is required, for example for particularly demanding applications, elZinc® titanium zinc can be supplied both bright-finish as well as pre-weathered with additional factory treatment.

If design requirements are high, for example for façades or in visible areas, thicker panels are used because the extra panel thickness contributes to a higher inherent stability of the tilted construction elements.

03.1.2. ZINC STRIP (COILS)

Small coils; approx. 30m / 6 coils per pallet. (internal diameter: 300 mm)
1-tonne coils and large coils. (internal diameter: 508 mm)

Bright-rolled and pre-weathered (elZinc Slate®, elZinc Graphite®, elZinc Rainbow®) coils.
Formats:

- Width: from 70 mm - 1000 mm
- Thickness: from 0.2 mm to 1.5mm
- Weight: from 50 kg to 10,000 kg

Weight calculation

elZinc® titanium zinc is a relatively lightweight material as roof cladding. This is significant, in the case of renovations if old roof cladding is replaced by a modern elZinc® -Roof.

Generally the “new roof skin” made of elZinc® titanium zinc weighs less than the existing solution or is light enough that static recalculations are not needed.

ELZINC® TITANIUM ZINC SHEET THICKNESS	WEIGHT PER m ² [approx. kg]
0,65 mm	4,7
0,7 mm	5,0
0,8 mm	5,8
1,0 mm	7,2
1,2 mm	8,6
1,5 mm	10,8

Table 6: elZinc® titanium zinc weight data

A precise calculation of the basic weight of an elZinc® titanium zinc covering must include the extra weight of the seams at either side of each bay. There is also a (very slight) weight addition from the anchors.

The basis weights of elZinc® titanium zinc plain, and pre-weathered are practically identical. The specific weight (density) of elZinc® titanium zinc can be calculated on the assumption 7.2 kg/dm³.

ELZINC® SHEET THICKNESS [mm]	PANEL WIDTH [covered width]	SEAM POTION	STRIP WIDTH [width to cut to size]	WEIGHT LAID SURFACE [approx. kg/m ²]
0,70	520 – 530 mm	13,2	600 mm	3,02
0,80	520 – 530 mm	13,2	600 mm	3,46
0,70	590 – 600 mm	12	670 mm	3,38
0,80	590 – 600 mm	12	670 mm	3,86
0,70	620 – 630 mm	11	700 mm	3,53
0,80	620 – 630 mm	11	700 mm	4,03
0,80	720 – 730 mm	9,6	800 mm	4,61
0,80	920 – 930 mm*	7,5	1000 mm	5,76

Table 7: Basic weight of an elZinc® titanium zinc roof cladding

* The sheet width (covered width) from 920 to 930mm (from the 1000mm section) has also been used; Since the fastening points in this very wide panel are very wide apart this width is no longer used on roofs and is also no longer admissible according to the specialist rules; see table 13





04.
elZinc[®]:
TITANIUM ZINC FOR
ROOF CLADDING

04.1. ROOF SYSTEMS - AN OVERVIEW

04.1.1. "COLD ROOF": ROOF STRUCTURE WITH BACK-VENTILATION:

The "double-skin, rear-ventilated roof structure" is the traditional, proven method of metal roofing ("cold roof"). This roof structure takes into account particularly effectively, that sheet metal roof claddings - unlike shingled or slate roof claddings for example are "absolutely watertight".

This means the special advantage of this roof structure lies in the fact that any possible tiny amounts of moisture infiltrating into the roof structure due to low diffusion tightness of the interior layers or leakages of the vapour inhibitor or vapour barrier from the inside can be reliably drained away in the rear ventilation level.

The rear ventilation level is in this respect a security level for the reliable drainage of moisture which infiltrates into the inner roof structure in an unplanned way or at spots where there is damage. Because of this "additional security", the double skin, rear-ventilated roof structure has established and proved itself as the **standard solution for metal roofing**.

Schematic roof design of an elZinc® double lock standing seam roof with rear ventilation

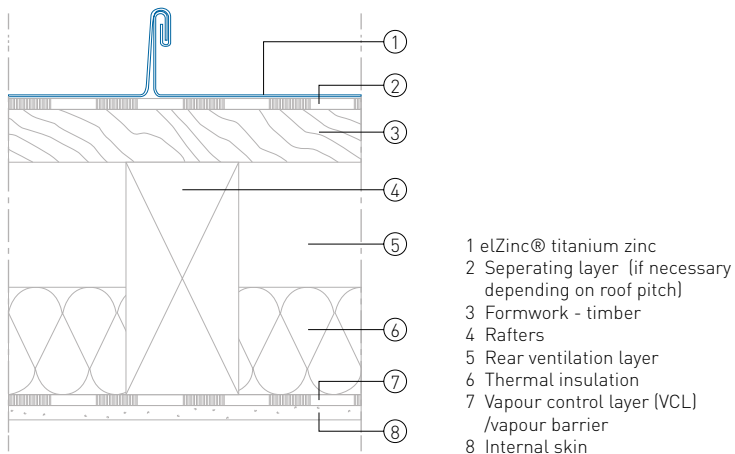

General advantage of the rear-ventilated roof structure:

In specific weather conditions, metal roofs can cool down so much that condensate forms on the underside of the sheet, which cannot evaporate through the sealed metal roof skin.

This means that the gently pitched roofs (up to 15°) are in principle provided with an evaporation level (“drainage level”), in which a “separation layer with a drainage function” is installed. Since evaporation is particularly effective when the moisture can be diffused into the rear ventilation level and drained away there, this means that a roof structure with rear ventilation is also preferable from this point of view.

04.1.2. “WARM ROOF”: ROOF STRUCTURE WITHOUT REAR VENTILATION:

Because local conditions often do not allow a very thick roof structure and because roof structures are becoming ever thicker due to increased heat insulation requirements, roof structures are also being increasingly designed and built without rear ventilation.

Because often the “required centimetres” for making the rear ventilation level are often lacking and because the making of the separate second skin, which the elZinc® titanium zinc covering directly bears, is naturally linked to costs, the necessity of having rear ventilation is called into question. Specifically because a twin-shelled roof structure requires a greater construction height or in the case of refurbishment, if areas previously covered with bitumen or films are recreated, planners will also investigate the possibility of a warm roof design.

Making a single-skin roof structure without rear ventilation, due to lack of an “additional security level” determined by the system, does indeed require very special care in making the interior layers that provide a diffusion barrier to avoid soaking the roof system, but with careful planning and implementation a roof structure without rear ventilation using elZinc® titanium zinc is absolutely secure.

This means that elZinc® titanium zinc is also provided for warm roof coverings, if the physical structural framework conditions are right in principle.

Account should be taken as from when the decision on the system is made of the fact that, due to the somewhat higher physical structural sensitivity, the warm roof structure imposes particularly high levels of requirements on the care and coordination of the individual trades right from the planning phase and throughout the whole implementation as well.

Schematic roof design of an elZinc® double lock standing seam roof without rear ventilation

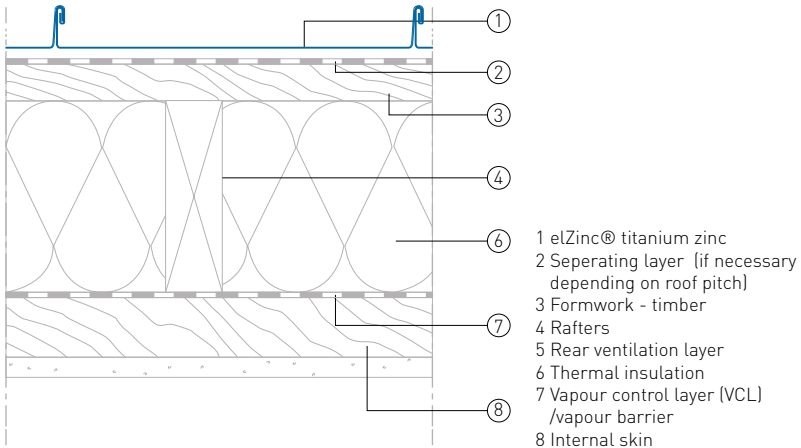

The sizing and installation of the vapour barrier must be designed for the expected temperature gradient between inside and outside layers.

The minimum sd-value of 100 m not is not usually sufficient to prevent the possibility of humidity diffusing from the room and it makes good sense to install vapour barriers with a metal strip insert as these are extremely diffusion-tight if fitted correctly.

Since condensate between the underside of the elZinc® titanium zinc and the substrate can never be ruled out (see above), it is recommended, even with steeper roof pitches, that the underside of the sheets is separated from the heat-insulating substrate by means of a separation layer with spacer fabric (“drainage membrane”).

04.1.3. “COMPACT ROOF”: ROOF STRUCTURE WITHOUT REAR VENTILATION ON VAPOUR BARRIER LAYER:

In principle, with metal roofing systems the compact roof structure is a very reliable solution, if the special features of the compact substructure are taken into account during planning. As a load-bearing

substructure, a compact roof comprises a heat-insulating substrate which is highly impermeable to diffusion and which already includes fixing points for the professional fixing of the elZinc® roof covering.

The advantage of this is that the roof structure is on the whole free of thermal bridges and watertight and is therefore very secure from a physical structural point of view with proper planning and implementation. Since the fixing points are inserted into the heat insulation and embedded in it with adhesive, there are no continuous joints or gaps of any kind in the insulation and vapour barrier.

As there are insulations which are made using special media (for example foamed), which become aggressive in contact with moisture, it always makes sense to ascertain the special features right from the planning phase and incorporate them into the installation specifications.

Because as a rule the whole roof structure, that is including the support layer of the compact roof element, must be taken into consideration, for example whether the design is exposed to vibrations, the inclusion of an appropriately experienced specialist engineer in the planning is recommended for these kinds of solution.

Since very good insulation values and a roof structure with very good vapour impermeability can be “flawlessly” achieved where there is professional design, constructions of this kind are also well suited to large roof areas, such as trade fair halls or roof areas over indoor swimming pools.

04.1.4. ROOF PITCH: IN THE CASE OF STANDING SEAM ROOFS

The recommended **minimum roof pitch** is 7°. In exceptional cases flatter roof pitches are technically possible (at least 3° = 5%), which then however require additional sealing measures such as sealing tapes to prevent slow drainage (building up behind the seam) or by wind-driven rain water. This is the way to prevent water that slowly runs off or is driven by the wind infiltrating into the structure.

For **roof pitches up to 15°** (26.8%), separation layers with a drainage function are to be incorporated in accordance with the general stipulations and technical rules.

In spite of all additional or special sealing measures, which also enable a flat roof pitch, the best protection for every seamed metal roof is however a greater pitch: as the roof pitch increases, the risk of dammed up seams diminishes and dirt deposits and atmospheric gases are washed off more effectively by the faster flow of the rainwater as it drains off (“self-cleaning effect”).

In particular in industrial areas or in the direction of the prevailing wind from dust emissions (e.g. in the vicinity of land used for agricultural purposes as well), thick deposits can build up over time on “very flat roofs”, which can then even have a corrosive effect on the metal roof, if the roof is not cleaned occasionally.

Roof pitch: zero: Barrel roofs and “smallest possible” roof pitch 3°

With domes or barrel roofs, in the highest area there is inevitably always an increasingly flatter surface up to a nil roof pitch.

elZinc® titanium zinc coverings can of course be used for these kinds of designs as well, in spite of the above-mentioned minimum angle of pitch: due to the special wind exposure of the highest point of a dome or barrel roof, experience tells us that there is no risk in this area of rainwater lying or flowing off so slowly that it could be backed up.

However, attention should be paid to the direction of the prevailing wind when orienting the seams. And, the seams in the area where the roof pitch is under 3 to 5° must be additionally sealed by inserting seals into the seam fold as a matter of principle.

Basically in the shallow pitch range up to 25° only one double lock seam is admissible. In particularly critical situations it is possible to increase the seam height, so that driving rain is not driven up into the seam even under unfavourable weather conditions and then possibly drawn into the interlocking joint by capillary action.

Effects of the roof pitch:

ROOF PITCH	ADDITIONAL MEASURES	SEPARATION LAYER	END LAP	INSTRUCTIONS IN SECTION:
0 – 3° (0 – 5.2%)	Sealing folds	with drainage function	avoid	4.2.1; 4.2.4
3 – 5° (5.2 – 9%)	Sealing folds	with drainage function	Avoid; if necessary seal; gradient step	4.1.4; 4.2.4
5 – 7° (9 – 12%)	Sealing folds	with drainage function	Gradient leap	4.1.4; 4.2.4
7 – 10° (12.3 – 18%)	None	with drainage function	Double transverse seam	4.2.4
10 – 25° (17.6 – 47%)	None	Recommended	Sliding joint with additional seam	4.2.4
> 25° (> 47%)	None	Not essential	Single lock seam	4.2.2; 4.2.4

Table 8: Dependencies on the roof pitch

Sealing seams by inserting sealing strips is only with double lock standing seams (see portion 4.2.1).

The sealing strip is applied to the lower fold and then folded into the seam.

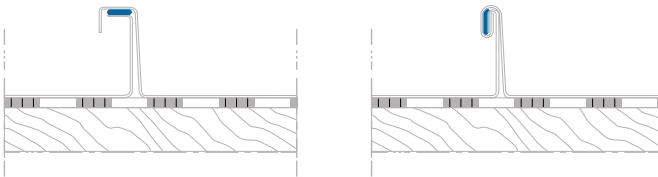

Location of sealing strip with elZinc® double lock standing

04.1.5. REAR VENTILATION: DESIGN OF THE AIR INTAKE AND OUTFLOW

“Cold roof” constructions, roof cladding with rear ventilation

The “double-skin, rear-ventilated roof structure” is the traditional, proven method of metal roofing (“cold roof”). The operability of this roof structure depends directly on the efficiency of the air feed between the outer shell which carries the roof skin and the inner shell.

The rear ventilation level is a special, precisely dimensioned level for the reliable drainage of from moisture, which penetrates the interior of the roof structure from the room via diffusion or unplanned via damage points. Because of this “additional security”, the double skin, rear-ventilated roof structure has established and proved itself as the **standard solution for metal roofing**.

The rear ventilation level is a special, precisely dimensioned level for the reliable drainage of from moisture, which penetrates the interior of the roof structure from the room via diffusion or unplanned via damage points.

The operating principle of the rear ventilation is that moisture in the air (for example moisture diffused from the interior through the room layers) is exited via air movement within the rear ventilation level (exhaust air opening) to the outside atmosphere.

The air movement is produced exclusively via the natural updraught of warm air. In other words the cold outside air, which enters at the lowest point (air intake opening), heats up in the rear ventilation level and so starts to move, taking the moist air with it.

Always note that this updraught has only a weak “engine”. In other words the resistances within the rear ventilation area are minimized as far as possible (for example, avoidance of narrowing internal structures, projections or other transverse developments which would interrupt the flow). It is also important for operability that “bottlenecks” do not develop, in other words that the upward-flowing air is not hindered from its upward exit. Therefore the exhaust air opening should always be made slightly larger than the intake air opening into which the air is sucked through the airflow.

DETAIL	ROOF PITCH 3 – 20° = 5 – 36%	ROOF PITCH > 20° = > 36%
Free air intake vent	1/500 = 2 of the roof area	1/1000 = 1 of the roof area
Free air exhaust vent	1/400 = 2.5 of the roof area	1/800 = 1.25 of the roof area
Height of the free space with air flowing through	min. 10cm	min. 5cm

Table 9: Recommended minimum values for rear ventilation
[Standard-roof forms and structures]

The values in Table 9 apply for normal rafter lengths of up to around 10 to 12m length, ridge – eaves. With shorter rafters the height of the space through which air freely flows can be reduced slightly but the minimum height of 4 cm up to a roof pitch of 60° (173%) must be observed. In the case of façades (vertical rear-ventilated surfaces) the height the rear ventilation can be reduced to 2 cm.

DETAIL	FREE AIR INTAKE VENT	FREE AIR EXHAUST VENT	HEIGHT OF THE FREE AIRSPACE
very flat roof (pitch <1/6 roof depth) width up to approx. 10 m	1/500 = 2 of the roof area	1/500 = 2 of the roof area	min. 6cm
long rafters flat pitch up to 25°	1/400 = 2.5 of the roof area	1/800 = 1.25 of the roof area	>10m: min.10cm >15m: min. 15cm
long rafters low pitch > 25°	1/400 = 2.5 of the roof area	1/800 = 1.25 of the roof area	>15m: min. 15cm >15m: min. 10cm
Inwardly-pitched roof surface "Butterfly roof"	1/400 = 2.5 of the roof area	1/400 = 2.5 of the roof area	min. 15cm

Table 10: Recommended minimum values for rear ventilation
[Special roof forms]

In the case of special roof forms, as flow-friendly a design of the rear ventilation level as possible is particularly important; transverse leaps or flow-impeding internal structures are to be avoided as far as possible.

In principle the design should ensure as far as possible that the air can exit unhindered. In other words that the exhaust air openings on the ridge are large enough, particularly if for example the airflow requires multiple diversions to prevent the ingress of rain.

04.1.6. LENGTH EXPANSION, EXPANSION ALLOWANCE

All materials used in the building industry slightly expand when heated and contract on cooling. The structural metals all have a similar expansion coefficient which states by how much the length (width) of a part alters under the influence of temperature.

Connections and fasteners shall therefore be designed such that the parts can expand, contract or move closer to one another without damage in the event of temperature changes. In this case a **temperature difference of 100K**, i.e. from -20°C to $+80^{\circ}\text{C}$, is assumed.

The distances between movement compensators should be chosen dependent upon their design and the type and arrangement of the construction elements. Table 13 applies for the distance between the movement compensators.

Mathematical checking of the temperature-specific length alteration

In special installation situations if the expansion potential needs to be more precisely defined it is worth using computerised methods to determine the length change more precisely.

The calculation bases are the skin or profile length, the expansion coefficient and the temperature difference with respect to the installation temperature. In this case a temperature difference of 100K, i.e. from -20°C to $+80^{\circ}\text{C}$, is assumed. Unless particularly extreme relationships prevail, this can safely be applied to the whole of the central European region.

This length change should be taken into account in the installation of the skins or elements, for example wall claddings etc.), such that the maximum deviation from the laying temperature downwards (contraction) and upwards (expansion) is calculated:

Calculation example:

If applying the normal temperature interval of 100K (-20°C to $+80^{\circ}\text{C}$) and a laying temperature (core temperature) of 25°C , 55K act on the elongation and 45C on the contraction of the component.

elZinc® titanium zinc has a thermal expansion coefficient of 0.022 mm/m K. In a component length of 10 m the following values are obtained:

$$\begin{array}{r} \text{Elongation: } 10 \times 0,022 \times 55 = 12,1 \text{ mm} \\ \text{Contraction: } 10 \times 0,022 \times 45 = 9,9 \text{ mm} \\ \hline \text{Total length variation: } \qquad \qquad \qquad 22,0 \text{ mm} \end{array}$$

Respectively half the lengths given in Table 11 apply for the distance of the expansion compensation potential (movement compensators, sliding potential) from corners or anchor points.

NR.	INSTALLATION SITUATION	CLEARANCE
1	Directly attached or permanently elastic, full-surface glued coverings and flashing	approx. 3 m
2	in the water-guiding surface for glued surrounds, angle connections, gutter hooks	6 m
3	for rails, extruded profiles etc.	6 m
4	Indirectly attached wall claddings, roof edge connections, apart from water-guiding surfaces	8 m
5	Shed gutters	6 m
	internal, unglued gutters with cutting length more than 500 mm	8 m
6	internal, unglued gutters with cutting length more than 500 mm	15 m
	Suspended gutters with cutting length more than 500 mm	10 m
7	Skins of roof claddings and wall claddings	10 m
8	Skins of roof claddings with special measures, with special longitudinal sliding and special eaves and ridge fastening	approx. 15 m
9	Skins of façades and external wall claddings with special requirements for flatness and evenness	6 – 8 m

Table 11: Maximum rigid connecting length of installation parts and maximum distances of expansion compensation options

Metal connectors which are glued in place need to have an adhesion surface at least 120 mm wide. Connections must be water-tight. At lengths over 3m the fastening should be indirect in principle.

It is recommended to attach construction elements such as for example wall or ledge claddings in visible areas, exposed to direct sunlight (solar heating), directly only up to an extended length of approx. 2 m to safely prevent stress-related (minor) rippling.

04.1.7. MINIMUM SHEET THICKNESS CORRESPONDING TO STANDARDS AND GENERAL RULES

Skins for roof claddings and façades are regularly manufactured from strip material. Profiles for edgings, flashing and other construction profiles are correspondingly manufactured according to requirements from strip- or panel material in different dimensions and forms and can even be pre-fabricated to customer specifications.

Standard sheet thickness for construction elements made of elZinc® titanium zinc are 0.8 mm and 1.0 mm, even 0.7 mm for less-stressed construction elements. Skins for roof surfaces are produced depending on the skin width (see also Table 7) from 0.7mm and 0.8mm.

For construction elements in the directly visible area, sheet thicknesses should be as large as possible to ensure very good inherent stability

The minimum sheet thicknesses are sometimes defined in standards and general rules while empirical values are the deciding factor for other construction elements.

DETAIL	SIZE	NOMINAL SHEET THICKNESS
Stop plates		0,8mm; 1,0mm; 1,2mm
Bays	Blank size > 700mm Blank size > 700mm	0,7mm; 0,8mm; 0,8mm
Claddings in demanding visible areas		0,8mm; 1,0mm

Table 12: Guideline values for sheet thicknesses

It is always important to take into account temperature-specific expansion. When construction elements, for example covers or connections, have quite a few joints, it is important to check whether stress- and strain- free movement is possible if the construction elements are subjected to fluctuating temperatures.

In general, indirect fastenings are required, for example anchor strips, roll caps, stops etc.

04.2. STANDING SEAM ROOFS

04.2.1. DOUBLE LOCK STANDING SEAM COVERING

The “double skin, rear-ventilated roof structure” (cold roof, see section 4.1) in elZinc® titanium zinc is well established in practice. In this case the full surface of the titanium zinc is laid on a supporting rough-sawn wooden formwork, if necessary separated by a separation layer. The ventilated interim zone above the heat-insulated substructure is separated from the bare covering by a vapour inhibitor or vapour barrier.

Double lock standing seams are generally always used in the roof pitch range up to approx. 60° (173%). Regulations generally specify the double lock seam for roof cladding as the sole seam alternative.

From roof pitches of at least 25° (47%), and/or of at least 35° (70%) in particularly exposed or snowy regions the double lock standing seam can be replaced with the angled standing seam (see portion 4.2.2).

Roof pitch

The recommended **minimum roof pitch** for a double lock standing seam covering is 7° (12%). In exceptional cases flatter roof pitches are technically possible (at least 3° = 5%), which then however require additional sealing measures such as sealing tapes to prevent slow drainage (building up behind the seam) or by wind-driven rain water.

There is no maximum roof pitch for double lock standing seams. Double standing seams can even be used for vertical surfaces i.e. for facades (see section 5).

Design of the double lock standing seam

The minimum height of the final seam is 23mm. The normal seam design results in a height of approx. 23 - 25mm.

Manual folding results in heights of approx. 27mm.

In snowy regions or if there is a danger of overflow over the seam, the height of the final seam can be increased to approx. 35mm.

Usually the bay is pre-profiled in production. The seams are simply interlocked and sealed during fitting to form the double lock standing seam. In

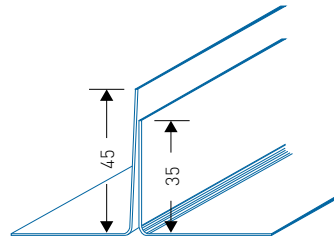

this case the ideal height of the finished seam is approx. 23mm.

The individual stages in the actual making of a (Belgian) roll cap system are shown in the figure.

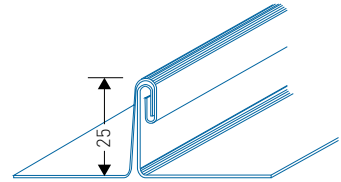
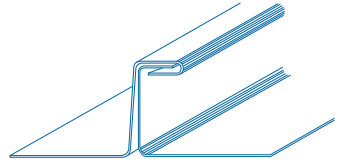
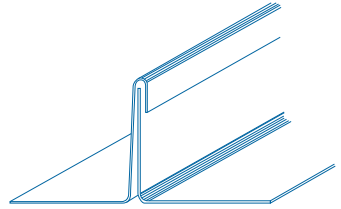

Expansion option

The roof skin is attached to the substructure by fixed and sliding anchors (see section 4.2.3).

The bay can expand in the longitudinal direction in the sliding anchor region.

Transverse expansion is ensured in that there is a distance of 3 to 5mm between the bottom edges of longitudinal upstands.

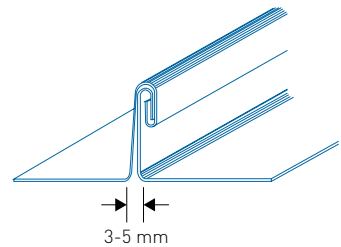

04.2.2. SINGLE LOCK STANDING SEAM SYSTEM

The single lock standing seam is a variant of the double lock standing seam, in which the seam is not completely folded over but is left horizontal so that when viewed from above the wide surface area emphasizes the optical effect of the skin division.

Roof pitch

Roof systems with single lock standing seams require a greater roof pitch than double lock standing seam roofs. According to the technical regulations, roofs require a pitch of at least 25° (47%) for the angled standing seam method.

Additional seam sealing by means of inlaid sealing tape is not possible with single lock standing seam; in particularly snowy regions or adjacent to valleys in which snow can collect and would not melt until spring, therefore, the roof pitch should be at least 35° (70%) or more.

Design of the single lock standing seam

The minimum height of the final seam is 23mm. The normal seam design results in a height of approx. 23 - 25mm.

Manual folding results in heights of approx. 27mm.

Usually the skin is pre-profiled in production. The folds are simply interlocked and closed during fitting to form the seam.

In this case the ideal height of the finished seam is approx. 23mm.

The individual stages in the actual making of a (Belgian) roll cap system are shown in the figure.

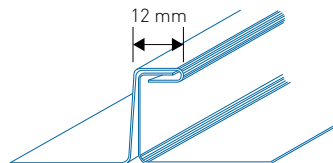
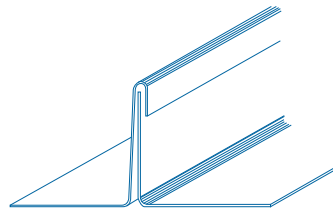
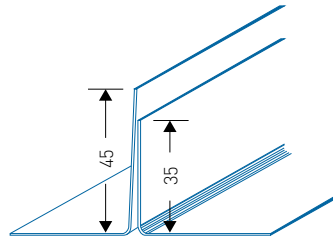

04.2.3. CLIPS POINT AREAS: FIXED CLIPS AND SLIDING CLIPS

Attachment to the substructure

The roof skin made of elZinc® titanium zinc strips (double lock standing seam and single lock standing seam) is attached to the formwork with clips. Clips are fastening elements comprising one or more elements normally made of stainless steel (minimum thickness 0.5mm).

Fixed clips and **sliding clips** are required. The clips are supplied for manual folding and for mechanical installation.

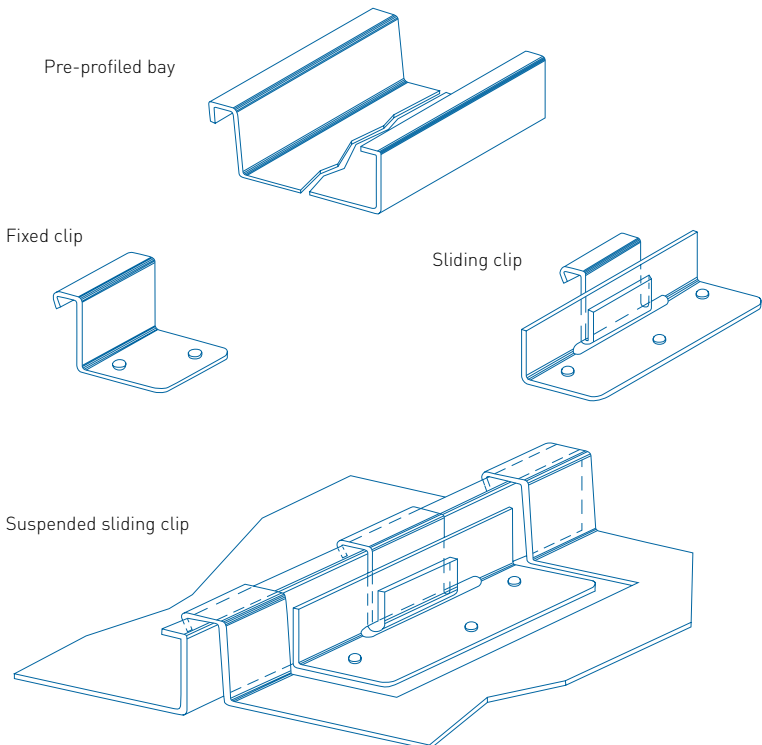

Fastening regions

To enable thermal length changes in the roof skin, fixed and sliding anchors must be used in a highly particular arrangement (see below).

The skin is attached to the substructure in the so-called “fixing point region” at intervals of approx. 1m to 1.5m by means of fixed anchors. Outside the anchor point only sliding anchors are used, which enable movement of the sheets in the direction of the eaves or ridge. The location of the anchor point depends on the pitch of the roof.

The figure shows the respective region of the fixed anchors depending on pitch in diagram form:

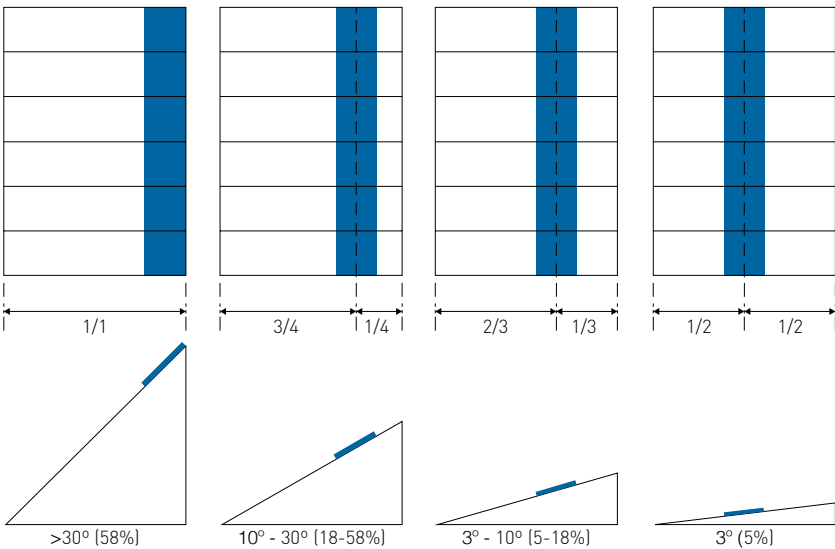

Number and spacing of the anchors, anchor fastening

Storm-proof attachment of the metal roof skin is guaranteed by the number of anchors per m^2 as specified by the regulations, their correct incorporation into the formwork, compliance with the correct anchor intervals and the respective maximum admissible bay width. In this case there is differentiation between normal regions and more stressed corner and edge regions

The different national and European standards and regulations provide instructions for the verifiable number of fasteners. The following minimum requirements are based on practical findings:

- In general the anchors are nailed with at least two hot-dip galvanized flat head nails (roofing nails) 2.8 x 25 mm with an anchoring depth of at least 20 mm, which gives an average extraction value of 560 N per anchor.
- In extreme wind conditions or in particularly exposed areas attachment by means of hot-galvanized recessed-head screws 4 x 25 mm is recommended; in this case an extraction value per nail of approx. 1600 N is achieved.
- 3.1 x 25 mm nails are used in compressed air nail devices with an extraction value of 500 - 800 N in 24 mm thick timber formwork.
- Staples (non-rusting steel staples with official certification) achieve an insert depth of 25 mm. At least three staples, minimum dimensions 1.5 mm thick, 10 mm wide, are used per anchor.

In special cases rivets are also used to attach the anchors, for example in a non-flammable substructure. The rivets, with 5mm shaft diameter and a 14 mm head diameter, can be made of wrought aluminium alloy. The length of the rivets is selected according to the thickness of the substructure.

The **maximum distance between the anchors** is generally 50 cm; even with smaller lifting stresses this distance must not be exceeded. The following Table 13 is a compilation of the details on the number the anchors for different building heights, strip- and bay widths.

The table also shows minimum **sheet thicknesses** which are to be maintained dependent upon the height of the building. The number of anchors per m^2 also depends on the type of surface.

It is necessary to differentiate between the “normal area”, i.e. the normal roof area, and the “more highly stressed surfaces”, i.e. the edge region, corners and areas particularly susceptible to wind.

The details in Table 13 relate to the normal wind load for inland buildings. Roof surfaces,

for example in wind tunnels formed by air flows being channelled between high buildings, or are on the coast or on high mountains, may require more anchors. In certain conditions it is wise to employ a specialist engineer to define the type and number of fasteners computationally.

Anchor spacings, strip and bay widths

BAY WIDTH [MM]	NUMBER OF ANCHORS PER M ² AT BUILDING HEIGHT [M]								
	UP TO 8 M			8M TO 20M			20M TO 100M		
	CETRE	EDGE	COR- NER	CETRE	EDGE	COR- NER	CETRE	EDGE	COR- NER
530mm, d = 0,7mm	3,9	3,9	6,4	3,9	5,5	9,6	3,9	7,7	12,8
600mm, d = 0,7mm	3,9	3,9	6,4	3,9	5,5	9,6	3,9	8,5	12,8
630mm, d = 0,7mm	4,0	4,0	6,4	4,0	5,4	10,0	not admissible		
730mm, d = 0,8mm	4,0	4,0	6,4	not admissible			not admissible		

Table 13: Wind exposure requirements (building height)

The height of the building determines which bay width is admissible in combination with which sheet metal thickness.

The specified number of anchors per m² is calculated based on the distance between the anchors and the width of the bay, taking into account the average extraction values (see above).

The **anchors for elZinc® titanium zinc** can be made of titanium zinc (thickness = 0.7mm), Galvanized steel sheet (thickness = 0.6mm) or non-rusting steel (stainless steel; thickness = 0.4mm). The base plates of the anchors should have rounded corners.

ANCHORS		GROOVED NAILS	RECESSED-HEAD SCREWS
MATERIAL	THICKNESS		
Titanium zinc	min. 0,7mm	Galvanized steel min. 2,8 x 25mm	Galvanized steel min. 4 x 25mm
Galvanized steel sheet	min. 0,6mm		
Non-rusting steel	min. 0,4mm	Non-rusting steel ⁽¹⁾ min. 2,8 x 25mm	Non-rusting steel ⁽¹⁾ min. 4 x 25mm

Table 14: Anchors, nails and screws; requirements for fasteners

The required formwork thickness in roof claddings must be at least 24 mm.

Per anchor at least 2 grooved nails or recessed-head screws with an anchoring depth of at least 20 mm.

1) Non-rusting steel, "Stainless Steel", stainless steels for nails and screws in accordance with DIBT approval

04.2.4. END LAP FORMS IN STANDING SEAM ROOFS

In the case of long roof bays, i.e. long lengths between the ridge and eaves, horizontal seams are required if the maximum length of individual bays is exceeded. Horizontal seams can be used for design reasons to divide up the roof area visually.

The transverse seam must be designed to be watertight, corresponding to the requirements of the installation situation, sufficiently strong and in the event of a corresponding arrangement of the transverse seam, enable adjustment in the event of thermal length changes.

In principle the tightness requirements come from the pitch situation. However additional sealing measures may be required even on even steep pitches if, due to special circumstances, the seams could be over-flowed (e.g. in the case of valleys). The minimum pitches to be taken into account according to ATV DIN 18339 and the specialist regulations for different designs are compiled in Table 15.

ROOF PITCH	TYPE OF END LAP DESIGN
< 7° (12%)	Watertight design with offset rivets with seal insert or soldering (avoid end laps with this roof pitch as far as possible)
≥ 7° (12%)	Double transverse seam
≥ 10° (18%)	Simple end lap with extra seam
≥ 25° (47%)	Single end lap (no added seal)
≥ 30° (58%)	Simple overlapping, min. 100mm

Table 15: End lap design depending on the roof pitch

Simple overlap

This joint is generally only used for flashing or cappings. The connection should only be used in areas with a steep roof pitch not susceptible to flooding.

Thermal length expansions are fully compensated for.

Single end lap

For roofs with slight pitch, no heavy driving rain (pooling water). The connection is effectively rainproof but not resistant to pooling, for instance due to driving rain.

Thermal length expansions are effectively compensated for.

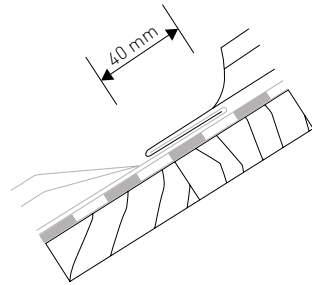

Simple end lap with extra seam

For roofs with slight pitch, no heavy driving rain (pooling water). The connection is effectively rainproof but not resistant to pooling.

Thermal length expansions are effectively compensated for.

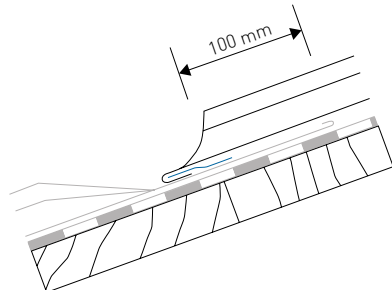

Double end lap (with and without seal)

The double end lap is the usual connection with for flat roof pitches or even panel systems. If a sealing strip is incorporated into the fold the connection becomes water-tight, in other words, resistant to (slightly) pooling water. However this transverse joint should not be used in areas designed to overflow (e.g. in drains) or where water exerts pressure.

Thermal length expansions are barely compensated for and another solution may need to be found.

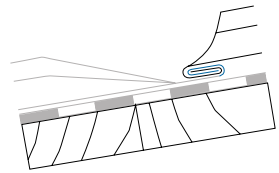

Gradient step

If length expansion must be taken into account in the case of very shallow roof pitches so that a double end lap cannot be used, the mobility of the eaves covering can be ensured by lifting the end lap off the roof surface to form a gradient step.

This design must be taken into account when planning the substructure. The height of the drop must be at least 60 mm.

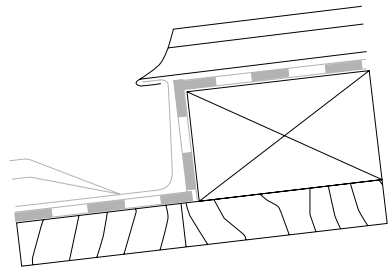

04.2.5. SUBSTRUCTURE

Titanium zinc standing seam roofs (non self-supporting bays) require a full-surface, nailed substructure, which is generally constructed in timber by the joiner. Every detail of the desired roof form is made in wood and is boarded out before the elZinc® titanium zinc roof skin is applied.

If, for technical design or fire-proofing reasons timber structures are not recommended, for example **mineral-bonded chipboards** can also be used which, however, are attached to a non-flammable substructure system, for example a metallic console system. The problem with this substructure is its extra weight and the dimensions of the panels.

Basically substructures, such as profile sheets (trapezoidal profiles) with a sufficient contact surface, are also possible; the precondition is always that the substructure is sufficiently stable, contains no corrosive components, is form-retentive and resistant in damp and the anchors can be sufficiently secured for the attachment of the sheeting.

The problem with materials other than the usual timber formwork can be that these layers are absolutely damp-proof and any condensation from the underside of the elZinc® titanium zinc cannot evaporate into the rear ventilation level. This means that any condensate films can only drain through the narrow airspace of the drainage level.

Boarded timber substructure (standard case)

Timber formwork is made of dry (30% humidity) softwood, rough sawn, squared, at least 24 mm thick, board widths 8 - 14 cm. Planks are laid parallel or at a slight angle to the eaves.

Boarding as supporting surface for a rear-ventilated roof construction

Tongue and groove boarding is not ideal because it can prevent any condensate forming on the underside of the titanium zinc-roof skin from evaporating into the rear ventilation level.

Large scale wood-based panels (for example weatherproof glued plywood boards or OSB boards) can be used provided one understands that the simple, direct moisture exchange from evaporated condensates into the rear ventilation level is almost impossible.

Eaves area with timber formwork

For the eaves area, particularly in the case of flat roofs the use of a gutter board (approx. 40 x 150 mm) is recommended, whose top surface should be approx. 5mm lower than the adjacent roof area so that the additional sheet thickness of the eaves-side attachment of the

sheets (stop plate, hook strips) is compensated for.

The design stage should incorporate all technical features, e.g. valley gutters, gutters, air intake and outlet openings, drops and verge and ridge ventilation and agreed with the contractor.

The anchorage and dimensioning of the roof sheeting on the structure itself should be ensured in accordance with the standards and specialist regulations for carrying out the joinery work.

Preparing and checking the substructure:

In general the substructure is produced as a preliminary assembly, generally by a joiner or a woodworker. Therefore **before starting the installation** the suitability and compliance with regulations of the substructure should be checked for the planned execution.

If this checking of installation capability is not carried out, then installers must take into account any difficulties and additional expenses as their own mistakes - often with considerable financial losses!

As a matter of principle, the following details are to be checked and where defects are detected, concerns are to be raised with the construction management or the planner:

- if the substructure has been handed over without sufficient covering and has got wet (wooden components must be “dry to the touch”; the wood humidity should not generally increase beyond 18 %)
- unsuitable subbase quality, for example where there are areas which are too rough, too porous, damp, dirty or oily
- insufficient thickness of the formwork, on which installation is to be carried out, sharp corners on the formwork and burrs, unevenness, no rounding of corners or edges
- insufficient fixing of the formwork, nails or fasteners not fully in
- missing or unsuitable fixing options on joints, recesses or feed-throughs
- missing aeration and ventilation for rear ventilated roofs or wall facings with rear ventilation
- unsuitable type and location of feed-throughs (for example, so that longitudinal seams would have to be interrupted), drainage, connections (if for instance a sufficient connection height cannot be created), joists, etc.
- variances of pitch or a horizontal run of a joint or edge or a smaller roof pitch than was laid down in the specifications, or than would be required professionally
- missing saddles on (wide) roof penetrations
- missing height reference points for locating joints
- due to the planning details insufficient possibilities for expansion and movement to be made
- missing substructure design, if the pitch means that a transverse seam needs to be formed

- by means of a gradient leap or the arrangement valley gutters is required
- due to the planning details bay widths too large



04.3. ROLL CAP ROOFS

04.3.1. ROOF STRUCTURE

The titanium zinc roll cap covering differs from the double lock standing seam covering in the square or tapered wooden battens attached to the substructure against which the lateral upstands of the sheets rest. The timber batten is covered by a batten cap. In this way the connection of the individual sheets gains a stronger profile and is structured.

The connection between the roll cap and the sheet upstand is precipitation-proof but is not resistant against dammed up water. Therefore the minimum pitch of 25° (47%) or 35° (70%) must be maintained in snowy regions.

The transverse joins, bay widths and length limits, anchor spacings etc. are the same as those of the double lock standing seam system. Roll cap coverings, like double standing seam coverings, are also designed as standard as a ventilated double skin roof structure (“cold roof”). It is however also possible to make batten cap coverings without rear ventilation. In this case the conditions cited in section 4.1. apply.

There are also different versions of the roll cap system. We differentiate between the **“Belgian roll cap system”**, the **“German roll cap system”** and custom systems. Acc. to the German VOB, the German roll cap systems should be used unless otherwise specified. In driving rain this design offers slightly greater safety against water ingress but is a little less flexible in terms of temperature expansions.

The Belgian system is used far more prevalently. With careful seaming, in the pitched roof area it offers practically as much tightness against driving rain as the more expensive German system.

Neither seam system however is as resistant to pooling as the other systems. The primary advantage of the Belgian system is in the clean edge design of the roll cap roof, which looks more attractive than the German design.

04.3.2. BELGIAN ROLL CAP SYSTEM

In the design of a “Belgian roll cap system” the lateral bays are folded up to the height of the wooden batten. The upward folding takes place without re-folding such that the roll cap is not connected to the sheet upstand.

The attachment of the sheets is by means of anchor strips which are placed beneath the wooden battens and nailed or screwed onto them.

The anchors are folded around the top ends of the sheet upstand and serve simultaneously as attachments for the batten caps.

A connection in the Belgian batted seam system is “largely rainproof” and is admissible from a roof pitch of at least 25° (47%).

If the roof is subject to high wind (driving rain) or is in regions which can be subject to heavy snow and the danger of drifting snow cannot be eliminated this design should be used only from a minimum pitch of 35° (70%).

Roof design in the Belgian roll cap system

The individual stages in the actual making of a (Belgian) roll cap system are shown in the figure.

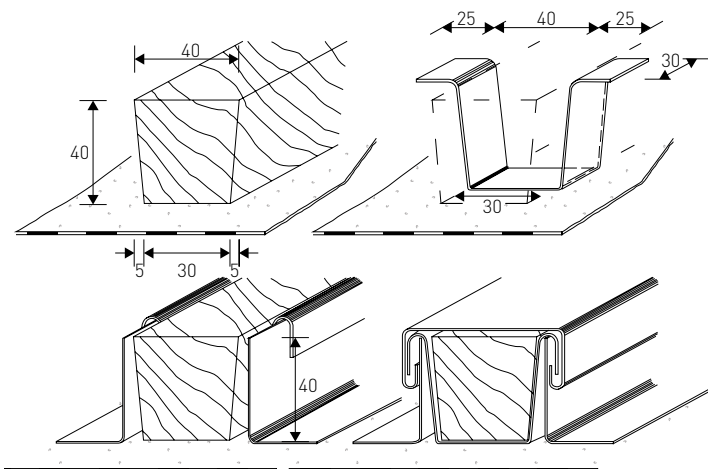

04.3.3. GERMAN ROLL CAP SYSTEM

In the “German roll cap system” the sheets are attached to the substructure with anchor strips which are screwed or nailed through the wooden battens to the substructure.

The lateral sheet upstands are folded outwards at the top end to the height of the wooden batten by approx. 90°. In this edging which must be at least 15 mm long, the strips anchors must be combined and folded in with the roll cap.

The roll caps are simply folded into the edge of the bay and form a horizontal or slightly downward-angled cover above the batten, and projects over the batten on either side by around 15 to 20 mm.

This design, if carefully made, forms a rainproof seal and in nearly-vertical areas or wall claddings it is preferable to the Belgian system in which the folding of the roll cap can allow water to get behind the seal in practically vertical situations.

Comparison of the German and Belgian roll cap seams

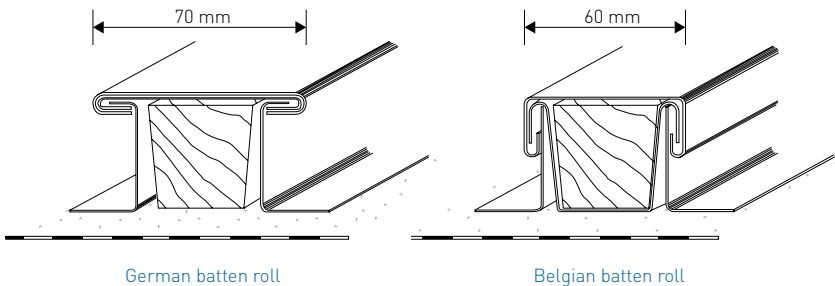

04.3.4. COMBINATION OF ROLL CAP SYSTEMS

A combination of the two above systems (“German roll cap system” and “Belgian roll cap system”) is a special form of the roll cap system. The roll cap, as in the German roll cap system, is connected to the bay upstand, which however is folded back as in the Belgian system.

The additional downward folding of the seam gives a particularly tight seal. If carefully executed, this more rigid edging of the roll cap as compared to the Belgian system combines the more pleasing appearance of the Belgian roll cap seam system with a good seal.

This combination of the two systems is even suitable for vertical surfaces and wall claddings in wind-exposed locations in which the Belgian system has only limited resistance to driving rain.

04.3.5. DISTRIBUTION AND WIDTH OF THE BAYS IN THE CASE OF ROLL CAP SYSTEMS

Intelligent distribution of the bays is the deciding factor for a visually appealing division of the roof area. A precise installation plan is needed to optimally combine the effect of the bay direction with the structure of the battens.

The surface division also depends on the strip width, wherein depending on the building height particular widths may not be exceeded (see also Table 13). Standard dimensions in the case of the roll cap system are also 600 mm strip cutting width and 0.7 mm sheet thickness. In the Belgian system this gives a final measurement (bay length from batten to batten) of approx. 560 mm, and approx. 530 mm in the German system.

The maximum bay length is 10 m; this length should not be exceeded because it is impossible to allow for extra movement using longitudinal sliding anchors for temperature expansions as in the double lock standing seam covering. In lengths greater than 10 m, interruptions are needed e.g. through gradient steps or end laps.

Due to the defined structuring of the roll cap seam surfaces, end lap interruptions are less obvious than with standing seam solutions, particularly the battens visually continue.

STRIP CUTTING WIDTH	mm	540	600	700	
Bay length Belgian/German system	mm	500 / 470	560 / 530	660 / 630	
Cap cutting size	mm	120 / 100	120 / 100	120 / 100	
Wooden batten 30 x 40mm / 40 x 40mm	meter length/m ²	1,7 / 1,8	1,5 / 1,6	1,4 / 1,4	
SHEET THICKNESS [mm]		kg/m ²	kg/m ²	kg/m ²	
Approx. weight of elZinc® roof skin (metal) per m ²		0,70	6,6	6,4	6,3
		0,80	7,6	7,4	7,2
Approx. weight of the elZinc® roof skin (metal + battens) per m ²		0,70	8,3	7,9	7,6
		0,80	9,2	8,9	8,5
Proportion of surface used		%	76 / 72	78 / 74	80 / 77

Table 16: Bay widths, strip widths; surface weight
Belgian system - left, German system - right

Wooden battens

The wooden battens have a **standard cross section** of 40/ 40 mm, often the width is tapered underneath to 30 mm (standard for Belgian roll cap system). However to achieve special optical effects you may also employ larger dimensions.

Taller battens are recommended for shallow-pitched roofs, particularly in snowy areas. To accommodate the thermal transverse expansion a gap of 3 to 5mm should be provided between the bottom of the upstand and the batten, which means that in the case of un-tapered battens the upstand may not be at a full 90° angle.

04.3.6. LAYING BATTENED ROOFS

It is recommended that sheets are pre-folded in the workshop or even on the construction site to achieve a very even spacing.

Alignment on the roof should take place very carefully and further installation steps are manual. In visible areas alignment should be carried out using a project -specific template. Due to the clear structure, even relatively small discrepancies are evident, particularly in shade.

All connections and endings are hand-made. Soldering should be carried out beforehand in the workshop as far as possible.

Attachment to the substructure

The sheets are attached to the substructure using clip strips which are nailed or screwed with the battens to the formwork. The strip clips act like sliding clips.

They prevent the bays from slipping.

The number of clips per m² complies with those for standing seam roofs (Table 13). Per m² roof surface at least 6 clips are required, in the edge region at least 8 clips per m².

The spacing between the clips may not exceed 330 mm or 250 mm in the edge region.

In the arrangement of fixed clipping regions, as in the case of the double lock standing seam system, the steeper the pitch, the further towards the ridge the fixed area should be. Basically in the case of steeper pitches (> 30° (58%)) the fixed clipping area should be at the top end of the sheet. It is recommended to form the fixed area with additional safety clips or clip strips.

The clips are cut out of titanium zinc (minimum thickness 0.8 mm) or Galvanized steel sheet (minimum thickness 0.7 mm) (see also Table 14 p. 30); stainless steel clips, thickness 0.5mm have also proven effective due to their rigidity.

The titanium-zinc sheets with upstands on either side are laid between the wooden battens which are attached perpendicularly to the eaves at corresponding intervals. They are held in place by the folded ends of the strip clips (Belgian system) or are laterally secured by the clips which are hooked and folded over the batten (German System).

The bays are folded over at the top and are held there by the retaining clips. The battens are tapered to approx. 60° in the eaves area.

The upstands on the sides of the bays can be folded around this angle. The fold at the bottom end of the bays folds around the stop plate and/or the fascia board.

Caps are then pushed over the battens from the eaves end. These are held at the sides by the folded ends of the strip clips and are nailed in place or secured to the top edge of the batten with spring clips.

The end pieces of these caps should be preformed on a corresponding forming block or using a template in the workshop.

Clean connections and end stops make an important contribution the visual appeal of the overall roll cap roof.

1. elZinc® titanium zinc bays
2. Ridge capping
3. Connecting plate
4. Roll cap
5. Separating layer
6. Formwor
7. Batten
8. Eaves plate

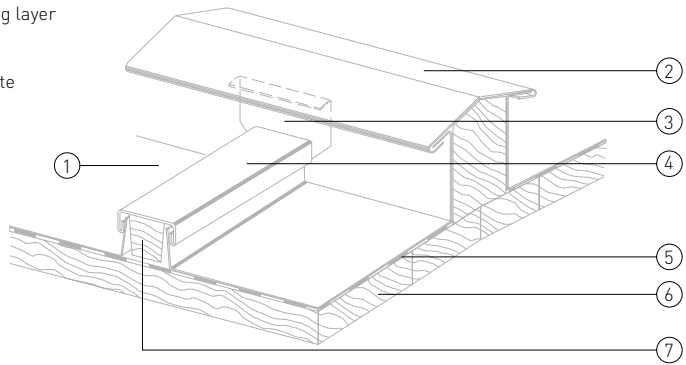

Ridge connection, roll cap roof

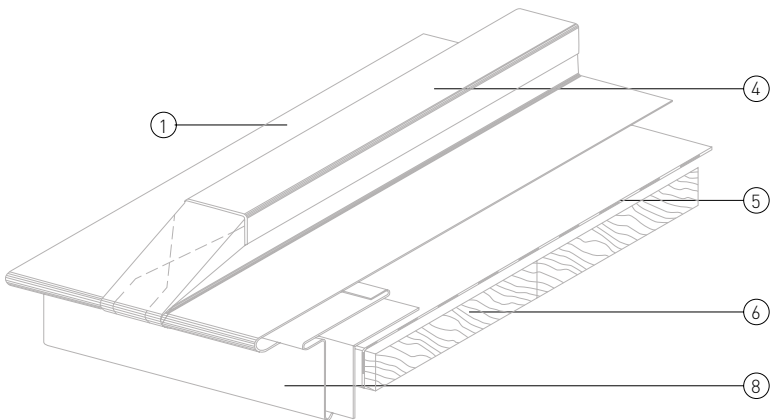

Eaves connection, roll cap roof

Taking into account temperature-related length changes

As with standing seam roofs, the thermal length changes of the batten bays must be taken into account. This is based on the linear thermal expansion coefficient of titanium zinc (0.022 mm/m C) for a temperature difference of 100K (-20° to + 80°C).

Therefore corresponding movement play must be allowed at the eaves to permit stress-free expansion of the titanium roof skin. The bay length and laying temperature must be taken into account when calculating the length change. As roll cap bays generally have their fixed areas at the top you always need to use the bay sheet length.

In the transverse direction the trapezoidal undercut wooden battens and/or the mandatory distance of the base of the bay upstand from the batten permits expansion of the bays in the horizontal direction.

The “double skin, rear-ventilated roof structure” (cold roof, see section 4.1) in elZinc® titanium zinc is well established in practice. In this case the full surface of the titanium zinc is laid on a supporting rough-sawn wooden formwork, if necessary separated by a separation layer. The ventilated interim zone above the heat-insulated substructure is separated from the bare covering by a vapour inhibitor or vapour barrier.

04.4. LOZENGE ROOFS

The lozenge roof covering differs from the seam and roll cap system. While the other two generally use longer sheet rolls, the lozenge system is made of many smaller equally-sized generally square panels.

A lozenge covering is less common, however very typical roof cladding with elZinc® titanium zinc. The individual lozenges form a mosaic with vertical and horizontal diagonals.

The lozenge covering with elZinc® titanium zinc is suitable both for large and small areas and even on curved surfaces the small panels can be optimally fitted and adjusted to the form of the substructure.

They are therefore particularly suitable for cladding gables and dormers, roof edges or chimney stacks.

A minimum roof pitch of 25° should be maintained in this case. Only with soldered apex angles can these values be reduced, however only to a maximum 18° roof pitch.

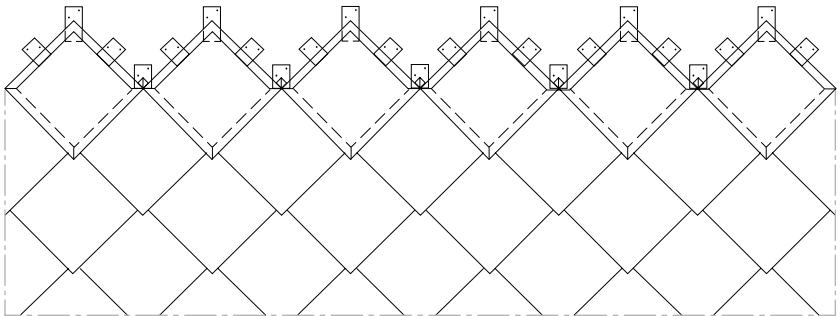
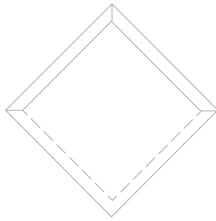

Diagram of lozenge roof

Lozenge forms

There are many different forms and sizes, however the most common are the square and rhomboid shapes.



Square lozenge

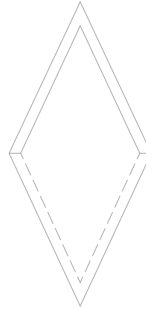

Rhomboid lozenge

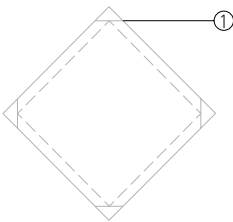

The folding of a rectangular shingle is shown in the drawing on the left.

The square sheets are cut at the corners along the cutting lines (1), the top two sides are folded along the seam line (2) towards the top of the plate (3) and the bottom two sides are folded back along (2) the seam line to the bottom of the plate (4). The lozenges are then attached with combined (6) and soldered (5) clips to the substructure.

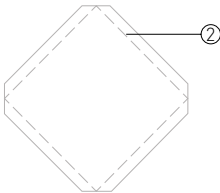

The drawing below shows the individual steps in folding a rhomboid lozenge. The process is the same as with the square lozenge.

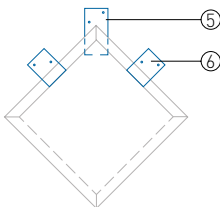
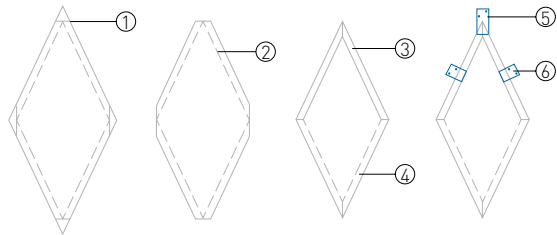
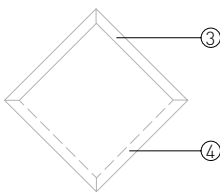

1. Cutting line
2. Folding line
3. Sides folded forwards
4. Sides folded back
5. Soldered clip
6. Sliding clip

The half lozenges are used for the starts and ends on straight edges, ridges or vertical components. The half lozenges can be attached at the “bottom” at the apex angle with a sliding clip or a soldered clip.

1. Cutting line
2. Folding line
3. Sides folded forwards
4. Sides folded back
5. Soldered clip
6. Sliding clip

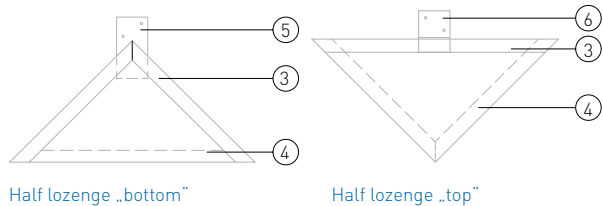

Types of clips

There are two types of clips for lozenges; sliding clips and soldered clips. Sliding clips are used on the folded sides and at the upper apex angle; soldered clips are used at the upper apex angle.

Substructure:

A lozenge roof must be completely attached to a timber construction. This should be made as far as possible from untreated and unplanned planks with a thickness of 23 to 25 mm.

With a roof pitch of less than 40° the substructure may only feature gaps of a few millimetres. From a roof pitch of 40° the gaps can be as much as several centimetres. There must always however be sufficient wood to attach the clips.

A lozenge covering must always be applied with a waterproof membrane. With low roof pitches these should feature a drainage layer to prevent corrosion of the underneath.

Attachment and connections

The assembly of a lozenge covering starts at the bottom edge or the eaves connection and travels from bottom to top.

For this purpose an eaves profile (1) is mounted with clips onto the substructure, into which the “bottoms” (2) of the half lozenges are hooked. These are then also attached to the timber construction with clips. In the second row, whole lozenges are (3) hooked in placed, offset to those in the first row. A marking line (4) should be drawn after every third lozenge to ensure that the tiles form a straight grid pattern.

Eaves connection, lozenge roof – view and section

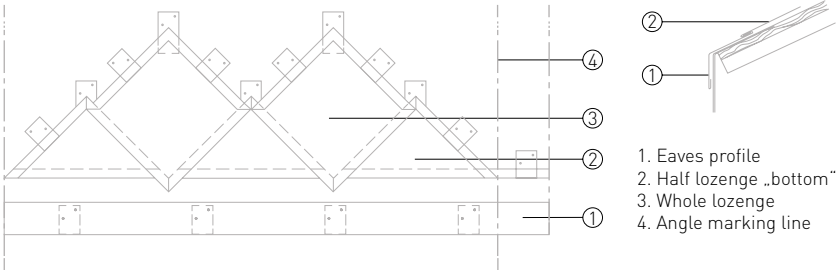

The most common attachment of the lozenge is with a soldered clip at the upper apex angle and respectively two sliding clips on the upper edges. The clips themselves are attached to the substructure with stainless steel or galvanized steel nails and/or screws.

At the upper edge, the ridge connection should also generally be finished with half lozenges. Otherwise whole lozenges are cut to shape and folded over the top edge. An edging profile at the eaves point is also used as an edging method.

Ridge connection, lozenge roof – view and section

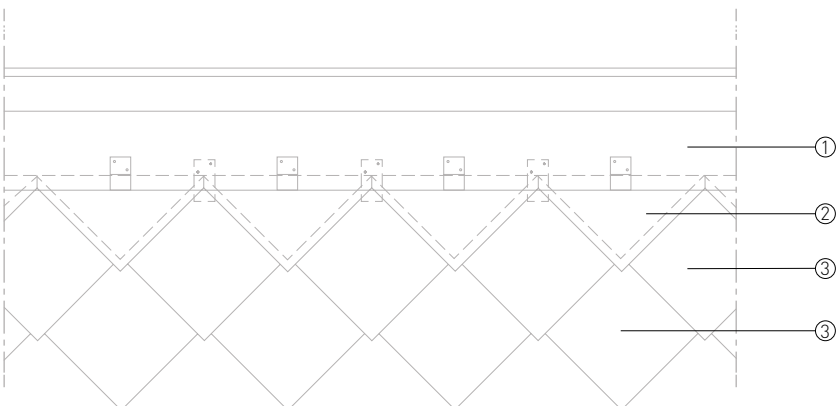

1. Ridge profile
2. Half lozenge "top"
3. Whole lozenge

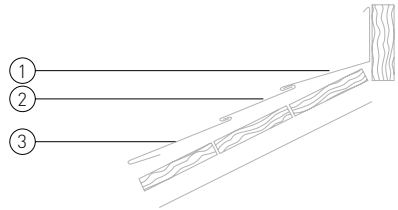

A further option for a finishing a lozenge covering at the ridge is e.g. to butt the lozenges against a wooden batten.

The verge edging is very similar to the ridge connection. Here too a suitable profile is usually used. There are several ways to finish the edge of the roof. Firstly one can lever up the verge and then use a folded profile to create the edging. A further method is to form the edging with a batten. This produces a more visually obvious edging.

Where components such as chimneys, ventilation ducts and windows occur, all these connections are used simultaneously.

04.5. GREEN ROOFS

Due to the ecological benefits, roof surfaces are being increasingly “greened”. The actual roof surface, which is generally flat or only slightly pitched, is sealed.

The adjacent borders, ledges, or circumferential roof surfaces are often designed as elZinc® titanium zinc standing seam roof surfaces. This raises the question of how water can be drained off the underlying roof surface. Often the design provides that the water from the substrate drains through the titanium zinc via a drainage system.

elZinc® titanium zinc is not corroded by water draining from underlying roof surfaces provided pooling is avoided. Pooling could lead to a concentration of substances which are a by-product of growth (humic acids).

Nevertheless it should be noted that the drainage water contains particles of dirt which can contaminate the elZinc® titanium zinc surface as well as dissolved non chemically-neutral materials, which interfere with the natural patination and can also cause severe discoloration.

It is therefore recommended that drainage water is channelled over the titanium zinc surface. For example the drainage water can be guided via a narrow bay with higher seams on either side until it reaches the gutter. This bay can be protected by a coating against discoloration and corrosion by the drainage water.

If this special bay is not in an immediately visible area, coating may not be needed because no serious effect on the durability of the elZinc® titanium zinc is to be expected. If the special bay pitch is very shallow, it is recommended that a sheet thickness of 0.8 mm is used, even if the surrounding roof area is made of sheet thickness 0.7mm.

- | | |
|---------------------------------------|--------------------------------------|
| 1. Plantings | 10. Support construction |
| 2. Plant carrier/Substrate | 11. Drainage gutter |
| 3. Filter fibre | 12. Tray |
| 4. Drain element | 13. Separating layer |
| 5. Impact protection | 14. elZinc double lock standing seam |
| 6. Root protection | 15. Box gutter with brackets |
| 7. Particle board formwrk | 16. Square timber |
| 8. Lattice with rear ventilatio layer | 17. elZinc Gable |
| 9. Mesh | |

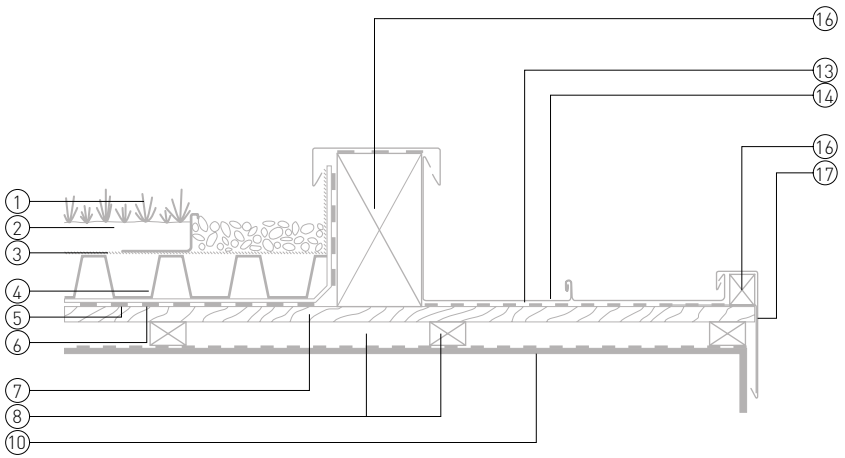
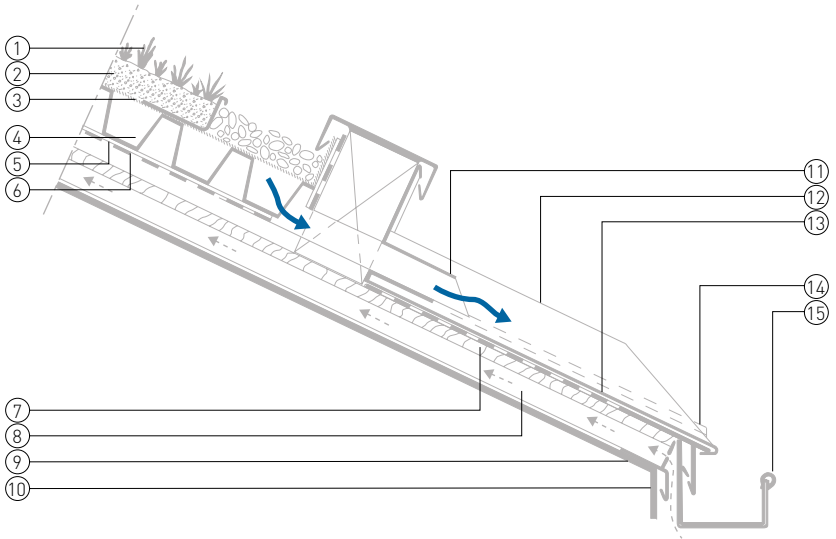

04.6.AUSBILDUNG DES FIRSTES

Exhaust air openings must be provided in the ridge area of a ventilated substructure. These can be of various designs depending on the size of the roof and type of use of the building.

One ventilation variant comprises the installation of so-called ventilated ridges. In this construction the bays which arrive at the ridge area are raised vertically by at least 150 mm, wherein an air gap of at least 80 mm must remain free.

This exhaust air opening is covered by a folded ridge plate which is held in place with metal staples attached to the rafters. The free openings are protected against the entry of small animals by mesh.

Additional folding of the cover plate and the nearby titanium zinc bays also protects against penetrating snow and driving rain.

For small roofs or if a ventilated ridge not is possible, it is possible to guide the exhaust air through **individual vents** in the form of air scoops soldered to the sheets provided there is a sufficient roof pitch (> min. 20°).

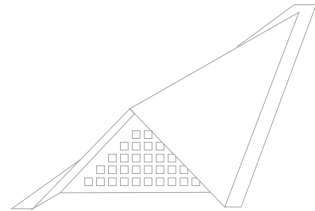

Ventilation of shallow-pitched roofs

For roofs with pitches of less than 7°, ridge ventilation is impractical due to the inadequate thermal conditions, in other words due to the minimal height difference between ridge and eaves. In this case therefore, adequately-dimensioned through-ventilation should be arranged from eaves to eaves (away from the closed ridge point) where this is possible.

Alternatively in such cases cross-ventilation from verge to verge can be used if the width of the roof area is no more than around 15 m.

In roof structures without ridge ventilation the ridge can be designed as a double lock angled standing seam or double lock standing seam or with ridge batten. If the bays are arranged symmetrically a double lock angled standing seam or a ridge batten design are recommended, respectively with a seam height of at least 40 mm, wherein the seams which reach the ridge area must be folded over.

If the ridge seam is designed as a double lock standing seam the bay seams on either side of the roof must be offset. The offset arrangement of the seams on the two sides of the roof benefits temperature expansion due to the smaller installation thickness.

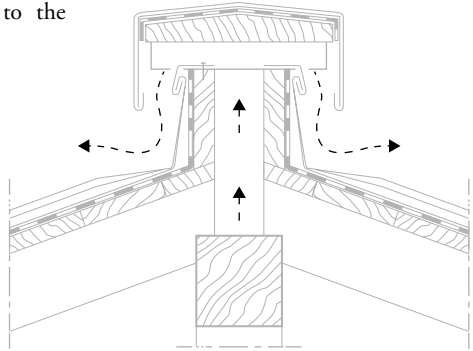

Ridge ventilation

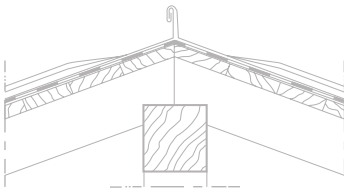

Ridge seam (in the case of transverse ventilation or separate ventilation openings between the bays)

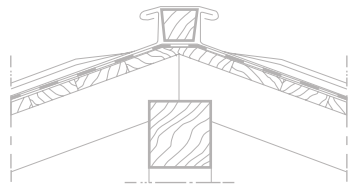

Ridge batten (in the case of transverse ventilation or separate ventilation openings between the bays)

04.7. BATTEN DESIGN

As well as the ridge, the batten also forms an edging to the bays so that here again, adequate expansion options are required. The pitch-dependent minimum height is at least 4 cm. Otherwise the same details as for the ridge apply to the batten.

04.8. DESIGN OF THE EAVES

The attachment of the titanium-zinc bays at the eaves is by means of strip anchors which are placed beneath the wooden battens and nailed or screwed onto them. The required material thickness depends on the size, blank width, shape, attachment and substructure; but is at least 0.8 mm.

Since the sheets are secured, depending on the pitch either at the ridge region or above the centre of the sheet by fixed anchors, the mobility of the eaves point is very important to allow expansion due to temperature.

This means that depending on the laying temperature, there must be sufficient space between the ends of the sheets and the stop plate to ensure that the sheets are neither obstructed nor stressed.

The elongation transverse to the sheet is absorbed into the seams. The ends of the sheets can, depending on the longitudinal seams take various forms (upright curved, tapered, upright straight):

We recommend using a template to cut to the end of the eaves so that the closed ends of the seams form a unified line at the eaves.

There are also devices for crimping the end of the eaves, which also guarantee very neat eaves edgings.

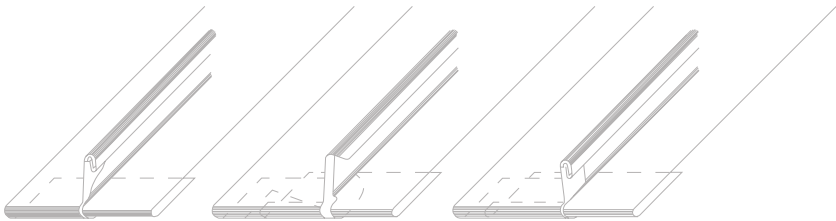

Unlike the “upright curved”, “tapered”, “upright straight” versions shown above, the folded seam which used to be considered as the standard design is now irrelevant because the folding and the doubling of the material creates a very rigid eaves edging in both the lengthwise and crosswise directions of the bay.

Particularly with longer eaves lines a folded seam may not be considered as sufficiently transversely mobile and experience has shown that cracks frequently form in this design.

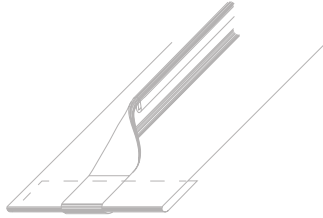

The standard solution today is the upright straight eaves edging (see diagram, top right); there are also special mechanisms for crimping the sheet end to provide a more attractive, more discrete overhang of the top of the seam.

04.9. DESIGN OF THE VERGE

The verge is always designed together with the ridge- and the eaves edging to create a visually unified and attractive pattern.

The verge edging is formed with a verge plate or verge board, which is attached to the bay upstand. The height of the bay upstand and the verge edging depends on the height of the building.

The spacings and heights in relation to the respective building heights are compiled in the following table.

BUILDING HEIGHT [m]	BAY UPSTAND AT VERGE (MEASUREMENT H)	VERGE PLATE EDGING (MEASUREMENT A)	MINIMUM DISTANCE OF DRIP EDGE FROM BUILDING
< 8	40 – 60 mm	≥ 50 mm	20 mm
8 – 20	40 – 60 mm	≥ 80 mm	30 – 40 mm
> 20	60 – 100 mm	≥ 100 mm	40 mm

Table 17: Standard dimensions for design of the verge

In taller buildings the distance of the drip ledge from the structure is increased, sometimes by up to approx. 60 to 100mm. Since with very tall buildings particularly however the wind load at the verge is very strong it is recommended that the drip ledge does not project too far outwards (wind load).

Verge, no batten

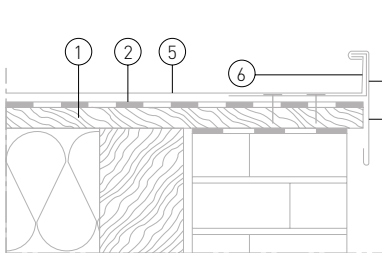

Verge with batten

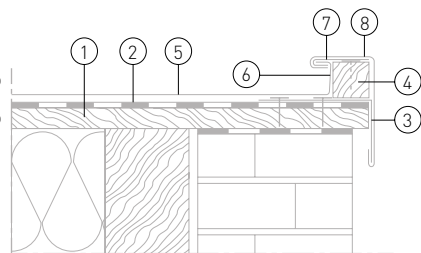

- | | |
|---------------------|------------------------------|
| 1. Formwork | 5. Double lock standing seam |
| 2. Separating layer | 6. Edge upstand |
| 3. Stop bracket | 7. Anchor |
| 4. Timber batten | 8. Verge capping profile |

The use of galvanized steel profiles (thickness at least 1.0 mm) is recommended to support the verge plate (stop plate) because a high degree of evenness can be achieved with this type of support.

During assembly of the verge plate and/or the verge batten a minimum spacing must be maintained of 2 to 3 mm between sheet upstand and the verge plate to allow for the necessary transverse expansion. Additional fastening may be necessary depending on the design and the plate thickness used.

04.10. CONNECTION TO VERTICAL CONSTRUCTION ELEMENTS, RIDGE-END WALL CONNECTION

The design of a connection in the longitudinal bay direction, e.g. to a wall leading to the ridge or a high ridge construction, depending on the design of the roof covering, for example, a double lock standing seam is ideal.

The connection height, depending on the pitch of the roof it is leading to, is 10 to 15 cm to guarantee adequate protection against driving rain.

In regions subject to high snowfall, at least 15 cm connection height should be allowed for connection to roofs with roof pitches of less than 15°.

If the facade which extends upwards is also clad with a seam system and a sufficient overlap of the connection is guaranteed, the connection height can be reduced to approx. 10 cm.

The seams of the adjoining bays are visually continued. For a neater finish, the “knife pleat” version is very attractive. If the connection height at the perpendicular wall is high enough, the vertical seam can be continued as a double lock seam to give the impression of a continuous seam, otherwise the upward seam is folded over to allow the end of the bay to be held and secured at the top with anchors.

Another option is to fold over the ridge-side end of the seam and then continue the tucked seam upwards. This design assumes that the seam is initially produced stretched before it can be folded in and fitted, in other words, that the bay is still movable and can be moved up the wall or that the ridge can be fitted later.

04.11. LATERAL WALL CONNECTION

The design of a lateral wall connection depends on the design of the facade or cladding of the adjoining wall.

In the case of brick or plaster facades the connection height, depending on the roof pitch, is 10 to 15 cm to guarantee sufficient protection against driving rain. In regions subject to high snowfall, at least 15 cm connection height should be allowed for connection to roofs with roof pitches of less than 15°.

If the connecting facade is clad with a seam system, the connection height can be reduced to approx. 10 cm.

Along with manual wall connection, the trade supplies various types of connecting strips, flashing strips and plaster rails or insert profiles.

Irrespective of the selected design, note that the metal bay is held movably by single or anchor strips and is sufficiently covered by an overhang strip such that even in unfavourable conditions, nothing can penetrate behind the top bay connection.

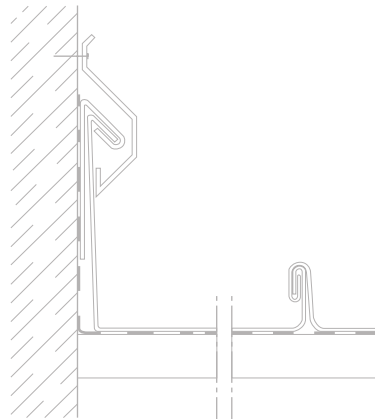

4.12. VALLEY DESIGNS IN SEAMED AND BATTENED ROOFS

Valleys represent the connection of roof surfaces which may meet at a non-specified angle. Valleys in this case can even separate different types of roof cladding although generally the adjoining roof surfaces have the same kind of covering.

The pitch of the valleys is for geometric reasons always less than the pitch of the adjoining roof surfaces:

If the roof surfaces are at 90° angle to one another and both roof surfaces have a pitch of respectively 7° (12%), the valley gutter pitch is only approx. 5° (9%)!

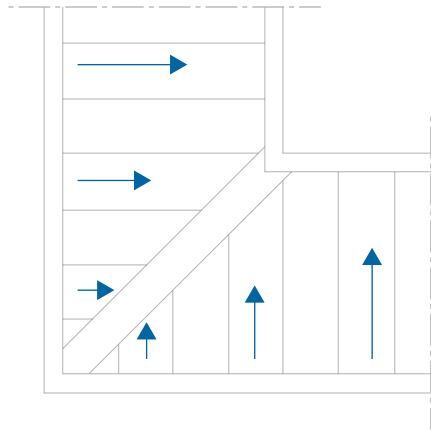

The design of the valleys depends on the valley pitch.

When checking the valley pitch, note that it is always less than the pitch the connecting roof surfaces.

The **connections between the actual valley bays** depend on the valley pitch. The lateral **connections of the roof bays** to the valley bay however depends on the pitch of the respective roof area depending on the respective roof surface (see section 4.2.4, page 29), so that the most appropriate connection can be chosen depending on the roof pitch in accordance with the rules for (in this case inclined) end lap joints.

The whole surface of the valley must always rest fully on the substructure. They form a part of the roof covering but are to be joined with lateral “mobility” to the roof surface such that the expansion of the bays which meet the valleys at an oblique angle is not impeded.

Valleys should in principle have an upstand or a water fold on both sides. In the case of pitch inclines up to 7° (= 12%) the valley connections should basically be recessed or in the

case of valley connection pitches of more than approx. 5° (9%) where possible, replaced with special bays.

When the length of the valley bay is more than approx. 10 to 12m, such an end lap is needed, the rules for end laps apply in accordance with section 4.2.4 however with valley pitches of 15° (27%) the join can be made simply by overlapping by a length of at least 100mm.

In the case of valley pitches of less than 15° (27%) the connection must be water-tight e.g. by soldering or offset sealing rivets, in this case the thermal length change should always be checked to prevent overload of the valleys through temperature-related stresses. It may be necessary to incorporate an expansion option by means of a soldered expansion absorber (Neoprene dilatation element).

04.12.1. RECESSED VALLEYS (VALLEY PITCH UP TO 7° (12%)):

For a valley pitch of up to 7° (12%) the valley connections must be basically recessed. This means that the two roof bays are connected on either side via a gradient step.

The valley design must be taken into account in the substructure, in other words the substructure must be designed correspondingly and if necessary the roof superstructure may even need to be reduced by reducing the insulation thickness.

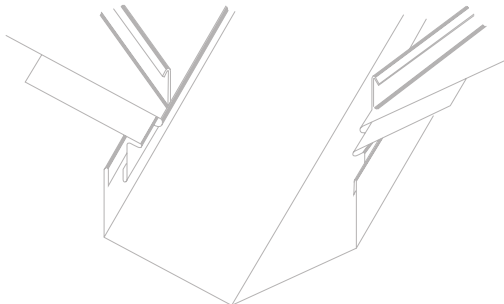

04.12.2. CUSTOM SOLUTION: REPLACEMENT OF THE VALLEY WITH CUSTOM BAYS IN THE CASE OF VALLEY PITCH FROM APPROX. 5° (9%):

If the valley pitch is at least 5° (= 9%) a continuous seam connection can be produced with correspondingly tapered bays in place of a recessed valley connection.

The designs of the substructure and of any end laps then correspond to the design of a normal standing seam roof.

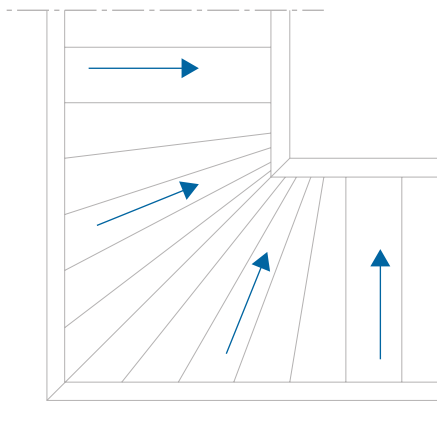

04.12.3. VALLEYS WITH A DOUBLE VALLEY SEAM (VALLEY PITCH 7° (12%)):

A double valley seam can be used with a valley gutter pitch from 7° (12%), into which are folded the adjoining roof bays.

Since the connections are very rigid, so that the length expansion of the valley bay is impeded, the length of the valleys in this design is limited to maximum 6m.

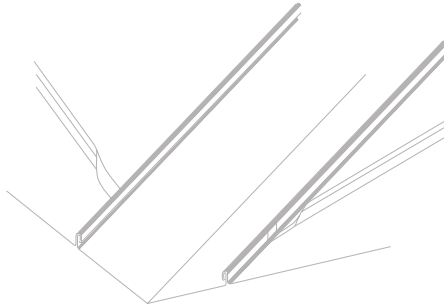

04.12.4. VALLEYS WITH A SINGLE VALLEY SEAM WITH ADDITIONAL SEAM (VALLEY PITCH 10° (18%)) OR WITHOUT ADDITIONAL SEAM (VALLEY PITCH 25° (47%)):

A single valley seam with additional seam can be used with a valley pitch from 10° (18%). If the valley pitch is at least 25° (47%), there is no need for the additional seam.

The adjoining roof bays are combined into the additional seam and/or the seam angle thereby forming a stress-free connection to the valley bay. This allows the valley bays to expand freely.

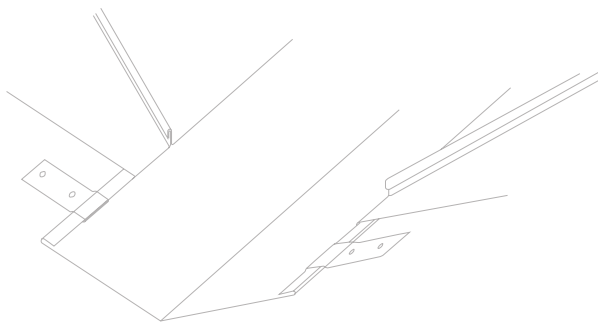
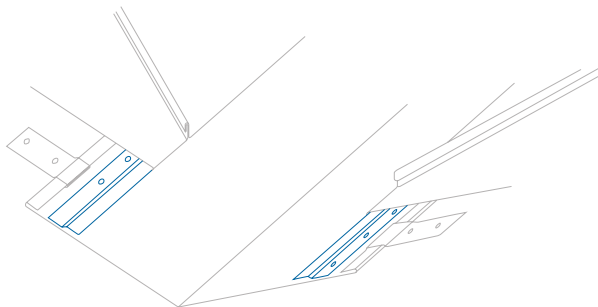



05.
elZinc[®]:
TITANIUM ZINC
FOR FAÇADES AND
WALL CLADDINGS

05.1. DESIGN TYPES

As in the case of roof claddings made of elZinc® titanium zinc, individual design and execution is also important for the project-specific façades and wall claddings.

Even if increasingly used in system solutions or prefabricated systems, facade claddings always involve individual, project-specific solutions, which require a corresponding design outlay.

The actual manual execution involves predominantly demanding connection techniques such as the single lock standing seam and the “German roll cap system“. Variants of these techniques and claddings are furthermore possible with small-scale elements.

The prefabricated facade systems require special laying- and joining techniques; these systems are supplied for special substructures and then fitted in accordance with the manufacturer’s instructions. The adjustments, attachments and edges are all manually executed.

05.1.1. MANUALLY FITTED CLADDINGS AND FAÇADES

In structural terms, exterior wall claddings made of elZinc® titanium zinc are viewed as vertical metal roof structures. The instructions and limitations with respect to attachment, ventilation, connection and dimensioning therefore apply accordingly.

elZinc® titanium zinc façades are both weatherproof and an architectural design feature. Thanks to the visual versatility of the elZinc® façades therefore, metal clad surfaces can also be combined with other materials such that a wall surface need not always be fully clad but can form partial areas in gables, fascia or parapet areas.

With appropriately adapted connection techniques, the bays can be laid at any angle or even horizontally, in other words the facade design can be fully integrated into the architectural design. With both traditional manual laying as well as with prefabricated systems, designers have plenty of freedom as the facade based on the “vertical roof pitch” offers a major guarantee of adequate tightness when correctly fitted.

elZinc® titanium zinc in façades can be incorporated into any roofing technique, i.e.

- Single lock standing seams, vertical seams
- Single lock standing seams, seam direction of up to 45°
- Double lock standing seams, vertical seams
- Double lock standing seams, seams practically horizontal, seams angled slightly forward

- Roll cap technique, vertical seams
- Roll cap technique, German system, seam pitch up to 60°
- Custom seam designs

Wall claddings are generally pre-profiled from strip in the workshop or in profiling machinery on the construction site.

Basically bays for wall claddings are subject to the same length limitations as for bays for roof coverings (see also Table 11). However for design reasons the lengths are usually significantly less.

05.1.2. FINISHES, APPEARANCE, EVENNESS

elZinc® titanium zinc basically exhibits a very high degree of flatness. If the customer specifies that the material should be especially suitable for use for facades, both elZinc® titanium zinc and elZinc®-pre-weathered can be supplied factory stretched and extra flat.

In the event of special requirements for the design of visible surfaces elZinc® -pre-weathered should always be used as this version anticipates natural patination and therefore the intermediate stages of weathering of the bright-rolled titanium zinc have already been completed.

Since façades are generally a particular design feature of the buildings, they must be very carefully handled in all processing stages, in other words during preparation of the bays in the workshop, during transport and also during storage on the construction site. This prevents contamination, fingerprints from the processing, soldering water traces etc. from marking and contaminating the surface, which under some circumstances can only be covered or concealed by the natural patination which develops after long weathering.

Since the modern profiling- and seaming machines are designed to be gentle on surfaces and on the pre-weathered surfaces which are sensitive to mechanical load, elZinc® -pre-weathered is generally used these days for facades and wall claddings in visible areas. This has the advantage that even in very uneven weathering of surfaces directly exposed to rain

as opposed to surfaces protected roof overhangs or rain covers etc. the appearance of the facade remains uniformly attractive.

If bright-rolled titanium zinc is used in facade areas to cut costs, the natural patination which forms (leading to the characteristic matt-grey colour) depending on weather exposure will certainly be very uneven. In this case, intermediate stages which feature dark matt grey areas next to areas of still bright metal will often incorrectly be described as “marks” or “discoloration”.

Bright-rolled elZinc® titanium zinc is highly reflective which means that even slight irregularities are very obvious on bright-rolled, un-weathered surfaces. Newly executed exterior wall and roof surfaces in bright-rolled, material depending on the angle of view and the position of the sun may appear significantly rippled, as processing can cause actually very slight surface irregularity, for example even with rolled copper, aluminium or stainless steel. From particular angles in this case surface, rippling may be very obvious, even though it is hardly noticeable when viewed close to.

This kind of slight rippling is not a fault and it disappears as soon as the natural patination which develops on the titanium zinc surface coats the mirror finish and makes it more matt.

For this reason, however, the pre-weathered version should be used for a facade or wall cladding if the appearance needs to satisfy visual requirements.

05.1.3. STRUCTURAL STABILITY, FIRE SAFETY, THERMAL INSULATION

The necessary verifications of structural stability and the compliance with the corresponding heat and fire safety measures must be agreed with the local building authorities and if necessary with the building physicist.

Depending on the respective national building regulations, building height and building location, different conditions may apply - particularly with respect to preventative fire protection.

If non-flammable substructures are required, you can use metal substructures for manually executed façade and wall claddings and for prefabricated systems. A cost-effective solution which is tried and tested in corresponding designs of anchor attachment is the use of a steel trapezoidal profile substructure, which performs as full-surface boarding.

05.1.4. SUBSTRUCTURE AND VENTILATION

The substructure which holds the titanium zinc exterior wall cladding is made in various ways depending on the design: Fully boarded, 24 mm thickness, for seam- and batten claddings; spot attached to mounting battens for cassettes and profiles. In addition there are special substructure systems for prefabricated facade systems which are used in accordance with manufacturer's instructions.

Timber formwork is made of dry (30% humidity) softwood, rough sawn, squared, at least 24 mm thick, board widths 8 - 14 cm. The boards are laid horizontal or at a slight angle to the horizontal.

The board width of 140 mm should not be exceeded in the facade because wider boards significantly increase the danger of dishing. The tongue and groove connection of the boards to one another has been found to be non-beneficial. More important is a secure attachment of the individual boards to the support.

Although boarding which has become wet is dried very effectively, particularly in rear ventilated wall construction s, the boarding once assembled should be protected effectively against rain because the softwood can distort during the drying process and no longer meets in full the requirements for a high-quality wall substructure.

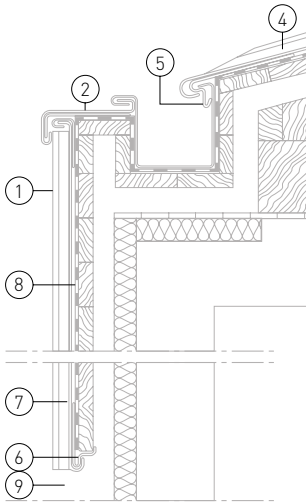

1. elZinc® external wall cladding (double or single lock standing seam)
2. elZinc® 0.7 mm covering (to stop plate 0.8 mm)
3. elZinc® square gutter
4. elZinc® double lock standing seam covering
5. elZinc® eaves plate (suspended) 0.8 mm
6. elZinc® base strip 0.8 mm
7. Separating layer (e.g. „V13“, talcumed)
8. Formwork min. 24 mm
9. Intake air opening (in skirting or stop area)
10. Ventilation space
11. Exhaust air outlet at highes tpoint
12. Turning point (transition from vertical to pitched area)

1. elZinc® external wall cladding (double or single lock standing seam)
2. elZinc® 0.7 mm covering (to stop plate 0.8 mm)
3. elZinc® square gutter
4. elZinc® double lock standing seam covering
5. elZinc® eaves plate (suspended) 0.8 mm
6. elZinc® base strip 0.8 mm
7. Separating layer (e.g. „V13“, talcumed)
8. Formwork min. 24 mm
9. Intake air opening (in skirting or stop area)
10. Ventilation space
11. Exhaust air outlet at highes tpoint
12. Turning point (transition from vertical to pitched area)

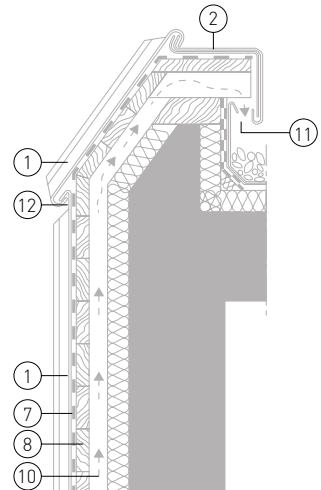

“Traditional formwork” for manually produced double-skin, rear-ventilated cladding has beams/squared timber (at least 24 x 48 mm² or 30 x 50 mm²) mounted on the bare wall, to which the wooden boarding is attached.

Horizontal section through elZinc® titanium zinc facade with timber substructure

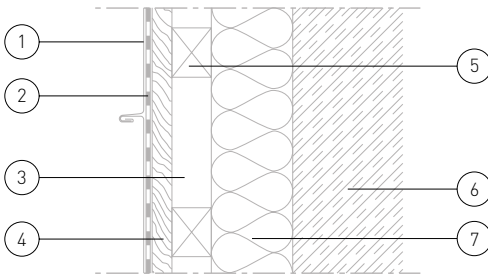

Vertical section through elZinc® titanium zinc facade with timber substructure

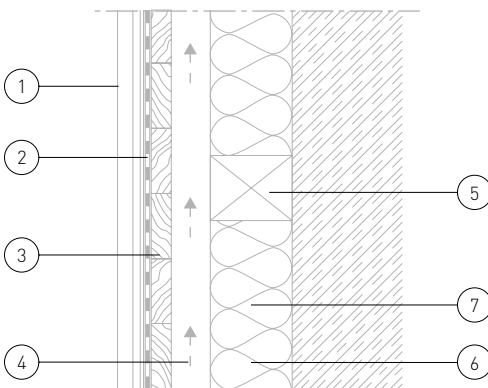

1. elZinc® external wall cladding (double or single lock standing seam)
2. Separating layer
3. Rear ventilation level (min. 40 mm)
4. Particle board or timber formwork
5. Support structure (square timber)
6. Wall (concrete, brick, etc.)
7. Thermal insulation

An adequate thickness of heat insulation (non-rotting and form-retentive) is placed in the spaces between the vertical beams. Ensure the heat insulation is sufficiently secured, it is not necessary to use “facade insulation” or extra laminated insulating boards with seamed or sealed claddings.

The design needs to allow sufficient space between the heat insulation and the formwork to ensure the necessary rear ventilation from bottom to top. The minimum depth of this ventilation space at any point must be 2 cm (available cross section). In timber substructures the provisions of DIN 68 800 “Timber protection in building works” or the corresponding national regulations must be noted (these comprise chemical protection processes for fungal and insect attack, blueing and fire damage). A separation layer is generally placed between the wooden boarding and titanium zinc for decoupling purposes. There are no special requirements for these separation layers.

The separating layer however should protect the timber substructure until the façade cladding has been applied.

In tall buildings, fire safety requirements necessitate a metal profile supporting structure if cladding e.g. very large, continuous surfaces. For this reason it may be beneficial to divide the cladding into several zones.

A tried and tested solution is to attach the elZinc® exterior wall cladding to steel trapezoid profiles which are attached with wall brackets or mounting fixtures through the heat insulation to the supporting wall of concrete or brick.

Horizontal section through elZinc® titanium zinc facade with metal substructure

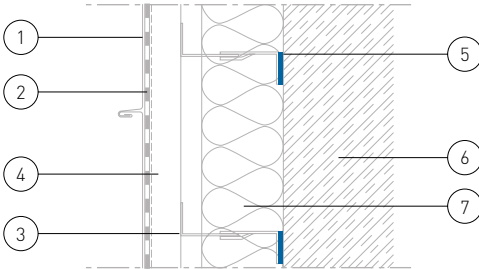

Vertical section through elZinc® titanium zinc facade with metal substructure

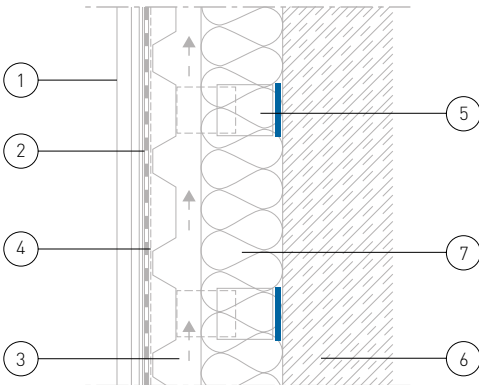

1. elZinc® external wall cladding (double/single lock standing seam)
2. Separating layer
3. Rear ventilation level (min. 40 mm)
4. trapezoid profile of coated steel with separation layer as decoupling
5. Supporting structure (adjustable brackets, wall mounting)
6. Wall (concrete, brick etc.)
7. Thermal insulation

05.1.5. INSTRUCTIONS FOR EXECUTION

Strip thickness, strip widths, division of bays

Careful division of the bays made of elZinc® titanium zinc or elZinc® pre-weathered provides a technically and aesthetically satisfying appearance of the metal cladding. For economic reasons in this case the standard 600 mm width is used which, with a single-lock standing seam-facade or even with double lock seam-claddings (as with roofs), gives a bay of length 530 mm (see also Table 13).

Compensating spacers are the n required in corner and connection areas.

Within particular limits of course other distances between centres are possible. Slightly narrower bays are often selected to create deliberate design effects. However custom strip widths require extra work because narrower strips are cut from standard widths and installation work is increased with narrower bay widths.

Basically the sheet thickness for wall claddings should always be somewhat thicker than would be required in a corresponding sheet width in the roof area. Naturally bays made of correspondingly thicker material are more form-retentive. In other words they are less likely to warp under temperature stresses or to ripple if the substructure is not exactly even.

Edges, drip edges, projections

The edges of sheet metal thicknesses of less than 1mm must be folded over to stabilise edges and prevent risk of injury on the sharp edge.

Rainwater drainage systems must be taken into account at the bottom end. Between the bottom edge of the facade surface and wall surface beneath there must be a distance of at least 20mm. If an angled drip plate is placed beneath the cladding for the protection of an underlying ledge or for general design reasons, the drip edge of this drip plate must maintain the gap of at least 20mm.

Attachment to the substructure

The attachment of the elZinc® titanium zinc wall cladding requires corresponding attachment elements. The cladding must be attached to the building structure in a way that is storm-proof and permanent, but must permit thermal movement.

For seamed or roll-cap wall claddings, the same anchors are used as with the corresponding elZinc® roof claddings. The anchor point is placed right at the top so that the expansion is only downwards. In relatively low facades which are divided by transverse joins for design reasons the fixed anchors can be located in the region of the transverse seams.

For the secure suspension of the strips in the case of long bays an additional continuous galvanized steel sheet is folded into the upper turnover for the attachment with fixed anchors of the top of the anchor point area to the top end of the bay.

An anchor attachment in accordance with Table 13 meets the requirements of the safe transfer of wind forces and all ensuing loads.

Tower coverage, panel cladding

For architectural reasons façade -cladding made of short bays can take the form of traditional tower coverings with offset end laps. The bays should be limited to a maximum 2.5 m because, due to the offset transverse seams, length expansion of the offset panels is practically impossible.

The offset heights of the individual panels can be selected for design reasons as required. Basically in this type of covering there are no fixed or sliding anchor regions. All side anchors are fixed anchors.

Therefore even in very neat installations minor stresses are unavoidable, particularly in south- and west-facing facades (sunlight) and slight warping can occur.

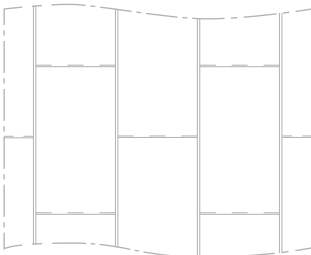

Normal anchor

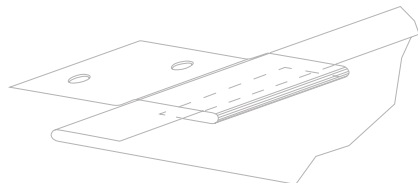

The individual short bays are arranged at offset heights and are connected to one another by end laps.

2 or 3 horizontal anchors are folded into the end laps depending on the panel width. Fixed anchors are folded into the longitudinal connections (because there is no differentiation between fixed- and sliding anchor areas) so the panel length is limited.

The anchors, like the anchors for roof claddings, are made of titanium zinc, galvanized steel sheet or stainless steel. Screw anchors, nails, screws, clamps, shackles and other metallic fastening elements must be made of non-corrosive material or be corrosion protected (preferably hot-galvanized).

Connections, edges

Depending on the design of the manual facade claddings, there are various connections for edges, skirting, parapets, windows and internal- and external corners. These are basically the “normal” connections and edgings from the roof area which are adjusted to the “vertical roof pitch”.

Titanium zinc-wall claddings must be covered at the top to prevent precipitation getting in, while not hindering the ventilation (see also section 5.1.4).

Upper connection of fascia clading with seams running to top

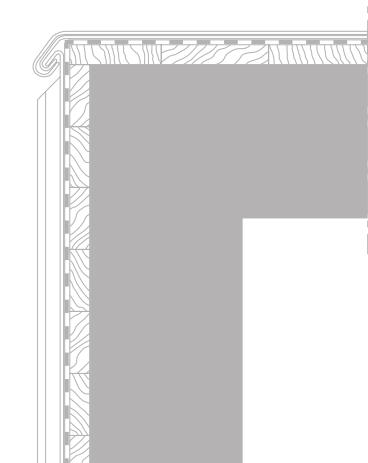

In the case of claddings e.g. on the fascia, it is possible, for visual reasons to have the seam running right to the top (i.e. not concealed beneath a cover with overhanging drip ledge).

Nevertheless a safe means of prevention of rear ingress should be created using strip anchors or an anchor strip folded in at the top. Allow also a sufficient overlap at skirting- and parapet connections (see below).

Metal connections on top surfaces consist of one limb which is integrated into the cladding and another upward limb which is attached to the vertical wall element.

The connection height of the wall-side limb is based on the pitch of the connection surface. In snowy regions it may be necessary to increase the connection height.

Differentiation is made as follows:

- Eaves connections
- Lateral connections
- Ridge connections.

The design of the connecting plates should allow for expansion as well as for settling movements, distortion etc. To prevent major distortion, the connecting plates should incorporate under-support or be inherently stable.

Individual lengths of up to 3 m are allowed for **rigidly connected attachments**. Two-part connections consist of a connection bracket which is covered by a separately applied overhang plate.

Lateral connections are either **underlying** or **overlapping**.

In the **underlying connection** the laterally connected cover lies over the lateral metal limb which is incorporated into the cladding. The metal limb can also be formed like a channel with recesses or webs. The simplest connections must have a water fold of at least 15 mm.

The laterally attached cover must overlap the underlying metal limb by the following amounts;

- roof pitches up to and including 35° : 120 mm
- roof pitches of more than 35° to 50° : 100 mm
- roof pitches of more than 50° : 80 mm

unless a positively-engaging connection is made through which sideways driving rain cannot penetrate, even in wind.

Upright lateral connections cover the adjacent lateral cover by at least 120 mm, wherein an adequate seal by means of edge folding and sealing inserts is made through which sideways driving rain cannot penetrate.

Ventilation (two-skin, through-vented facade system)

Manually fitted facade claddings are attached in the same way as roof claddings to a full-surface substructure. The rear ventilation level, like roof surfaces, must permit a uniform flow. The intake and exhaust air openings are to be designed correspondingly. The intake openings should be placed as low down as possible, in other words at the bottom of the facade, and the exhaust air openings at the highest point.

Since vertical airflow is particularly effective, very small rear ventilation cross-sections suffice. The cross section area should however not be less than $2\text{cm}^2/\text{m}$ facade width, in other words the height of the rear-ventilation cross section through which the air flows should be at least 2cm at all points.

Particular edge- and surface stability is achieved with wide stop plates in the skirting area. The lowest seams (turn-overs) of the cladding elements in their turn must have sufficient clearance so as not to prevent the thermal movements of the cladding sheets.



05.2. PREFABRICATED FACADE ELEMENTS

There is a variety of prefabricated facade elements made of elZinc® titanium zinc, e.g. cassette profiles, slot-in profiles, panels and corrugated profiles. The industrially prefabricated facade elements are generally made with a protective film which is peeled off only after fitting. This protects the surface during transport and storage, preventing it from becoming dirty or damaged.

We recommend including in the invitation to tender instructions to the effect that those elements to be used in visible areas be treated with extra care during the preparations for work, storage and use, to protect the high-quality surface from the dirt normally generated during building and protect it from damage. This applies particularly to pre-treated partial surfaces.

In some prefabricated facade systems the top-ventilated overlap of titanium zinc-wall claddings can be left out if open laminar elements are used which ensure adequate rear ventilation.

There must be at least 50 mm overlap of intake and exhaust air openings of the verticals in the case of smooth butt joints.

Industrially produced construction elements made of elZinc® titanium zinc are preferably designed for horizontal installation. The strength of elZinc® titanium zinc allows profiles which can be installed over large spans and profiles which accentuate the architectural design of the facade.

These profiles with preformed slot-in seams or undercuts can generally be fitted at oblique angles so the design architect can choose from a variety of design variants.

Substructure

The substructure and the attachment of the elements to the substructure are basically dependant on the system of cladding elements.

Special metal substructures are available for wide spanned profile elements which can also compensate for severe unevenness of the substrate.

Suitable substructures for laying smaller-scale prefabricated parts made of elZinc® titanium zinc are, depending on the pitch, full-surface timber boards, preferably of unplaned planks

of thickness at least 24 mm or laths. On surfaces pitched at up to 60°, installation should be onto a full-surface substructure.

In a roof pitch up to 40° (84%) the gaps between the roof boards can measure up to 10 mm. At a pitch of over 40° (84%) the gaps can measure up to 10 to 12 cm, wherein the arrangement of the anchors must be appropriate to the location of the roof boards.

If a lattice substructure is used, the minimum measurement for the horizontal laths must be 30 x 50 mm, with an available span of up to 80 cm.

When determining the dimensions and type of attachment and connections, use the manufacturer's specifications and in the event of adjustments or special features in the substructure it is important to involve expert engineers at an early stage.

Ventilation (two-skin, through-vented facade system)

Reliable ventilation requires particular minimum sizes for intake and outlet air openings. The height difference in this case influences the efficiency of the through-ventilation. Therefore it is important to place intake air openings at the lowest point possible, in other words at the bottom of the facade, and to arrange the exhaust air openings at the highest point.

The technical design must also take into account:

- Building type- and use
- Quantity and frequency of possible moisture ingress
- Building form and length of through-ventilated length
- Technical design height of the ventilation space and location of the building in the wind direction.

The rear ventilation of pre-fabricated facade elements is generally provided for by the profile system. Note that there is often no smooth, continuous rear ventilation because the profiles have angled reverse sides.



A close-up, low-angle shot of a dark blue roof structure. The image shows diagonal wooden or metal beams supporting the roof. A dark gutter runs horizontally across the lower portion of the frame. The background is a clear, light blue sky. The overall lighting is soft, suggesting an overcast day or early morning/late afternoon.

06.

6. SURROUNDS,
CAPPINGS AND
FLASHING

06.1. BASIC INSTRUCTIONS

As it is easy to re-form and is also very strong, and it can be soldered as well as glued and joined with all other joining processes, elZinc® titanium zinc is just about ideal for surrounds, edgings, joins, flashing, cappings etc, when the requirement is for precision and visual perfection.

The natural matt-grey colour of the naturally patinated elZinc® titanium zinc or of the pre-weather elZinc® titanium zinc blends into practically any architectural colour and design concept.

Profiles for edgings, flashing and other construction profiles are correspondingly manufactured according to requirements from strip- or panel material in different dimensions and forms and can even be pre-fabricated to customer specifications.

The basic instructions for protection against the effect of aggressive media, for example fresh concrete, building dust, acids and alkalis, and for protection against contact corrosion, for example when assembling with copper parts apply accordingly even for the smallest surfaces of surrounds or covers.

Normal sheet thicknesses are 0.8 and 1.0 mm or 0.7 mm for less stressed construction elements. If the profiles can be prefabricated in the workshop or prefabricated by the manufacturer to the specification of the customer it is recommended to make the parts as thick as possible for construction elements in directly visible areas as these then have a very good inherent stability. In the case of prefabricated profiles sheet thickness of 1.2 mm are even possible.

DETAIL	SIZE	NOMINAL SHEET THICKNESS
Eaves strips		0,7mm; 0,8mm
Cappings	Cutting size < 400 mm Cutting size = 400 mm	0,7 mm 0,8 mm
Borders		0,8 mm; 1,0 mm
Connections		0,7 mm; 0,8 mm
Flashing	Cutting size < 400 mm Cutting size = 400 mm	0,7 mm 0,8 mm; 1,0 mm

Table 18: Guideline values for sheet thicknesses

It is always important to take into account temperature-specific expansion. Since these construction elements frequently have relatively large amounts of fixtures and connection points or even rigid soldered connections, it is always important to check for stress- and strain-free movement if the construction elements are subject to fluctuating temperatures. In general, indirect attachments, e.g. with anchor strips, anchor strips, stop plates etc. are preferable.

Installation instructions

Depending on applications and the function of the component there are different installation options, like borders and flashing on chimney stacks, dormers and roof lights, connections to vertical brickwork, duct vents or outlets building service system exhausts, cappings and edgings. The design of the connections and edgings needs to consider carefully the functions of the individual construction layers.

To comply with the technical regulations for the fitting of capping-, border- and connection plates and their connection, **special accessories and substructures** are used which are not identical to the corresponding components of the large-surface roof- and facade elements.

Accessories for cappings and borders; terms, short explanation

Anchor

Anchors are fastening elements made of titanium zinc or galvanized steel sheet. The most important role of these anchors is the indirect attachment of titanium zinc covers, surrounds and -connections to the substructure. This means that temperature-related length changes must be possible, without moisture penetrating into the substructure.

The particularly careful attachment of the anchor and stop plates onto the substructure by means of screws provides the required high extraction values at gables and roofs (wind load!). Under normal circumstances securing of the anchors with hot-dip galvanised flat head nails 2.8/25 mm is satisfactory.

Normal anchors: for the suspension of edge plates, ledge covers etc.

Plate anchors: for holding down smaller borders, mobile attachment of a plate edge.

Toothed anchor: to prevent wall connections and edge plates from slipping. The teeth alternatively grip the top and bottom of the plate.

Trapezoid wing anchor: prevents wider brickwork and ledge covers attached with sliding and soldered seams from flapping in the wind and enables covers to “move” in the longitudinal and transverse direction.

Strip anchors, anchor strips: continuous anchor strips for suspension of edge plates exposed to higher stresses.

Wall rails: wall rails or suspension profiles are used for the neat attachment of cap plates (overhangs). Cap plates should be secured at least every 250 mm, wall connection-rails at least every 200 mm.

Normal anchor



Toothed anchor

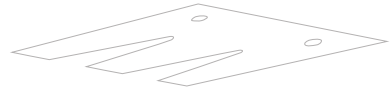

Trapezoid

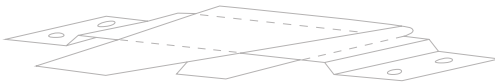

Plate anchor



Cappings, wall copings, ledge cappings

The most common method of attaching cappings is with continuous retaining plates, so-called anchor strips and/or stop plate brackets. These are attached with screw anchors and screws to the subsurface. These indirect attachments can absorb compressive- and/or tensile stresses caused by temperature-related length changes without stress.

Brick work capping with sliding seam

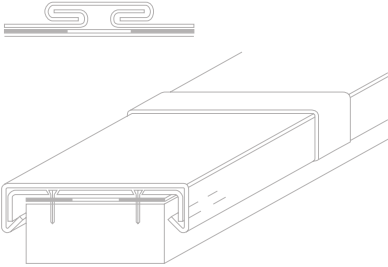

Coping with additional sliding seam

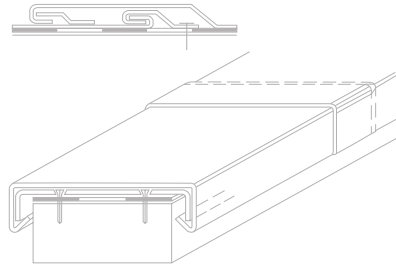

Coping with sealing underlayer

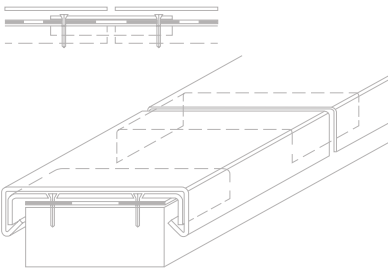

Expansion joint capping

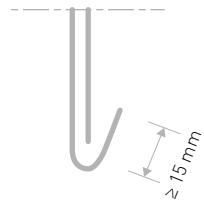

Detail

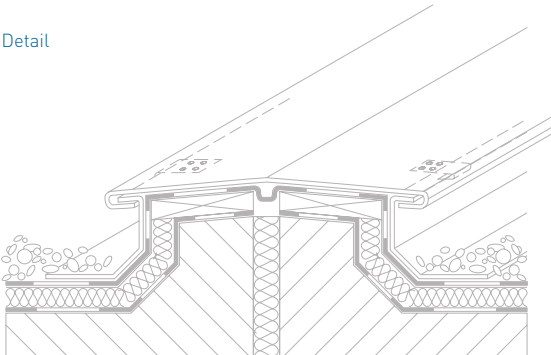

If using formwork timbers, these should be treated for mould and pests. Nailing strips and stud rails should be securely anchored to the subbase.

Direct attachment of the coping, e.g. by screwing on the profile, is not regulation-compliant. Temperature-related length changes can lead to stresses, dislocation and soldered seam breaks.

The connection of cappings to longer lengths, in other words between the expansion compensators, is generally by soft soldering. In some regions connections are formed by seams.

On an even, solid subbase gluing with a permanently elastic adhesive is possible. The soft plastic adhesive compound permits thermal movements due to its elasticity.

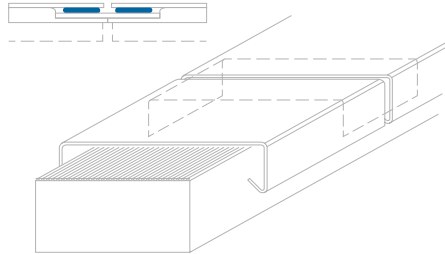

If the coping is glued to the subbase with a suitable adhesive compound (see also section 8.2 “Gluing titanium zinc with adhesive compounds”), the seam regions require at least a 10 cm flat underlay, also glued.

The parts to be connected are then attached at smaller intervals (approx. 3 mm), depending on the length of the individual coping profiles.

The connection of parts together must also be such that no stresses occur in the event of temperature expansion. Expansion compensators (standing seam, sliding option, inserted dilation element) must be fitted every 8m according to the specialist regulations (see also Table 11).

06.2. FALL

A transverse fall is always beneficial with cappings. It enables better drainage of precipitates and allows deposits and impurities to be carried off at the same time. In the case of fascia and roof edge claddings the fall should be towards the roof.

Additionally the side of the capping facing away from the roof can be provided with a small upstand so that rain is safely drained away to the rear and the facade is not marked.
nicht verschmutzt.

Window strip capping

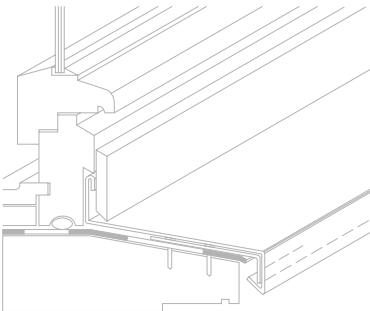

Ledge capping with sliding seam

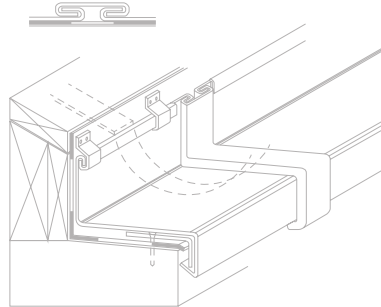

In window strip or ledge capping the fall must be away from the building. The facade below is then protected against marking by the drip edge (see table 19).

The production of the fall in detail depends on the substructure design.

06.3. SEPARATING LAYERS

An interim layer (separating layer) made of suitable material is installed to protect the substructure against the damaging effects of contact with other building materials (e.g. fresh concrete or wet mortar or concrete, aggressive wood preservatives) titanium zinc cappings and connections and titanium zinc flashing.

06.4. EDGE DESIGN, DRIP LEDGE

When designing cappings and forming the edge zone, along with the design aspect it should be noted that the draining rain water takes along with it dirt which can cause marking of the building elements beneath.

Therefore it is necessary for projecting metal cappings such as wall copings, window strips etc. to be a corresponding distance from the facade. The greater the distance, the less the danger of contamination and soaking through of the wall underneath.

COMPONENT	HEIGHT OF THE COMPONENT ABOVE THE GROUND LEVEL [m]	MINIMUM DISTANCE OF THE DRIP LEDGE FROM THE WALL BENEATH [mm]
Verge cappings, roof edge borders, fascia edging boards	< 8	20
	8 – 20	30 - 40
	> 20	40 - 60
Copings, width of copings with fall	< 8	20 – 40
	8 – 20	30 - 50
	> 20	40 - 100
Ledge cappings, windows strip cappings	< 8	30
	8 – 20	40 - 60
	> 20	60

Table 19: Standard measurements for the size of drip edge overhangs

The general regulations require a minimum distance of the drip ledge of 20 mm to the structure. It is recommended however, depending on the exposure, to increase the distance of the drip ledge for extra protection of the building fabric.

In higher buildings, if the distance of the drip ledge from the structure is increased, note that particularly on high buildings the wind load is very severe at the verge or roof edges. The use of galvanized steel profile (thickness at least 1.0 mm) is recommended for the support of cappings. This type of support can offer excellent rigidity and evenness of the component.

The edge of the capping is basically designed as a water spout (drip edge). This serves both to drain off the water safely and to add rigidity.

06.5. BORDERS

Feed-throughs of roofs and claddings, e.g. through chimneys, rooflights or pipe openings, are attached to the capping or cladding such as to be rainproof, e.g. by soldering, seams, rivets.

In this case according to the specialist regulations a minimum spacing of 200 mm is required between the opening and the longitudinal connection.

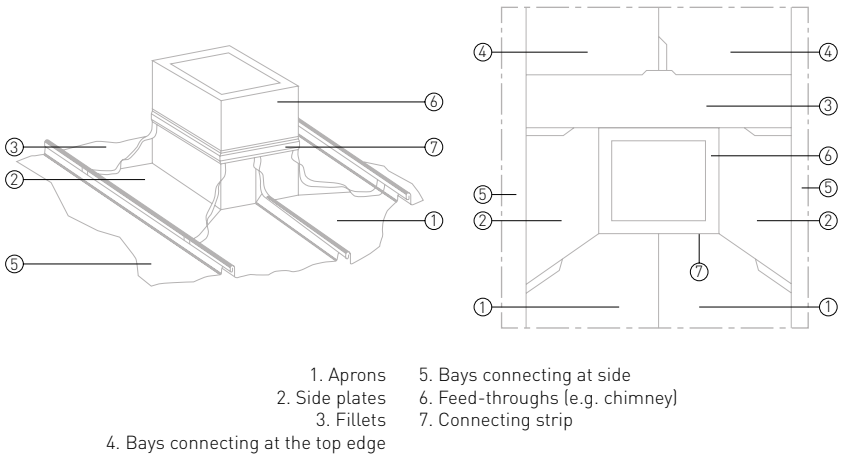

Cupolas or roof lights are “rigid construction elements”, whose base must be permanently anchored to the substructure. The eZinc® roof skin must be movably attached to this substructure to prevent temperature-related expansion from causing stresses.

It is recommended to use prefabricated titanium zinc roofing frame for borders for these types of components. This is supplied by the component manufacturers and offers sufficient connecting flange for folding into or soldering to the eZinc roof skin.

06.6. PIPE DIAMETERS, AERIAL ATTACHMENTS

The location of pipe openings is often distributed across the roof surface at random and it is not easy to take these openings into account when arranging the bays.

Nevertheless it is not generally possible to make an opening which is interrupted by a seam. If overriding factors make it impossible to take the openings into account when laying out the seams it might be necessary to raise the connection of the opening out of the water-drainage level by creating a small plinth around the opening which can then be bordered normally.

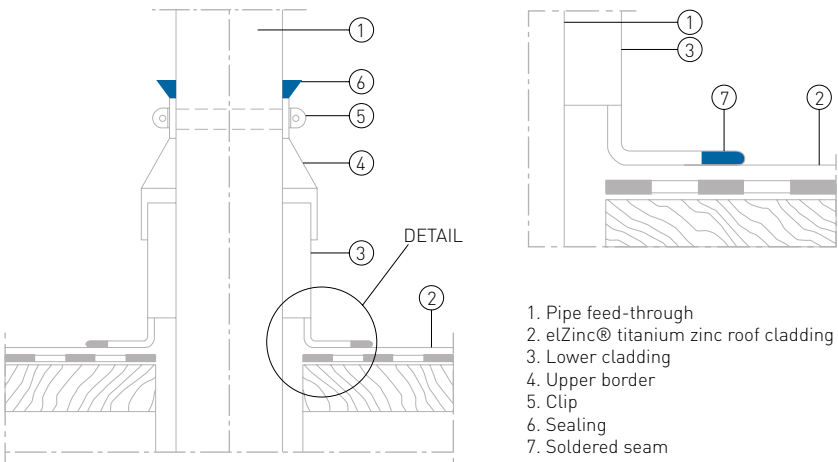

Design measures for compensating for temperature-specific expansions are as follows:

- Adherence to the minimum sheet thickness and recommended sheet thickness according to Table 13 and/or Table 18.
- Manufacture of “movable” connections and connections to rigid installation parts

(e.g. pipe openings in the roof skin) or in the case of adjacent roof surfaces, which have separate expansion methods (e.g. roof surface to dormer).

In special installation situations in which the expansion option must be more precisely defined, the expected length change is determined computationally. The basis for calculation is the bay- or component length, expansion coefficient and temperature difference to the installation temperature. Basically a temperature difference of 100K, in other words a temperature fluctuation of -20°C to $+80^{\circ}\text{C}$ must be assumed.

06.7. GLUING BELOW THE WATER LEVEL WITH BITUMINOUS SEALANT

Connections below the water level are subject to particular design requirements, particularly for the attachment of the sheet profile to the subbase.

The attachment must be to a certain extent indirect since a rigid attachment of the titanium zinc sheet would cause damage due to the prevention of the thermal length change. This in turn would lead to leaks in the structure.

The following measures should be noted:

The connections are attached at the first point of the roof seal with appropriate nails for the material. This need not be a (fully) frictional connection. This is achieved by stamping slots into the profile approx. 25 mm from the roof-side edge before laying.

The distance between hole centres is around 50 mm, so that every 70 mm the titanium zinc strip is held down by a nail; the nail should be hammered in so that it affixes the sheet to the underlay but is not too compressed. This ensures an unhindered length change of the metal.

An additional recommended measure is the arrangement of a separating strip of width at least 10 cm. This is laid unglued over the seam between the sheet/bituminous seal. Moreover according to the specialist regulations of the roofing trade an upper reinforcing strip of width at least 25 cm (e.g. polymer bitumen sheeting with non-woven polyester inlay) is required whose entire surface should be glued to the sealant. The surfaces to be glued are pre-treated with a solvent-based bitumen primer.

If sealing with plastic film the transition of the border/and the film roof covering is correspondingly sealed with film strips.

06.7.1. SEPARATION OF TITANIUM ZINC FLASHING AND BITUMINOUS ROOF SKIN

One method which is becoming increasingly popular is the deliberate separation of the bituminous roof skin or roof film and the flashing, which raises the roof edge of the bituminous or polymer seal out of the water drainage level and the titanium flashing then acts as a means of edge securing.

In this case the individual layers of the roof structure are raised via a valley or a corresponding nailing batten and mechanically secured against slipping. The join between the seal / titanium zinc profile (edge- and/or connection flashing) is thus raised out of the water level and then attached separately as a form of capping.

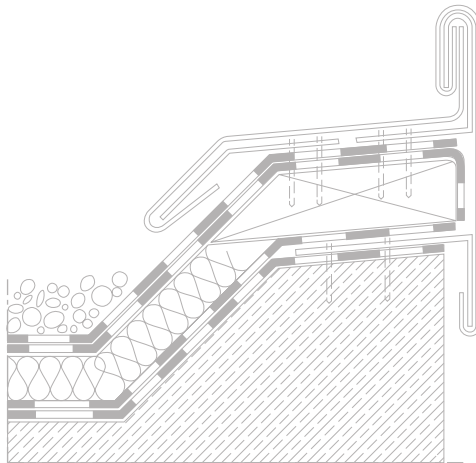

06.8. EXPANSION ABSORBERS (DILATATIONS)

If using very long sheet lengths, any borders below the water level should be fitted with dilatations every 6 m, and for cappings, connections and edgings out of the water level every 8m; respectively half these distances should be maintained for corners and edges and/or drops (see also Table 11).

Neoprene dilatations (commonly referred to as “Dilas”) permit the transfer of thermal length changes to the capping and border plates. They comprise a neoprene profile with titanium zinc-connections at both ends.

They are angled and interim-soldered like the plate profiles. Dilatations are independent construction elements, which must be specified in the invitation to tender.

Dilatations (“compensators“) can also be made as titanium zinc sliding seams and/or titanium zinc-sliding box connections.

Quite particular configuration variants have been proven to suit specific areas of use. For cappings and borders outside the water level a so-called flat sliding seam is possible.

Within the water level sliding box connections are required for roof borders and wall connections. Dilatations must be at least 600 mm deep. Their construction requires good knowledge and manual skill in sheet forming.

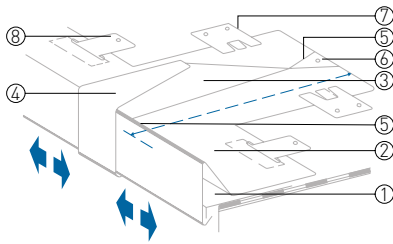

Dilatations (sliding boxes) for roof border

- 1. Stop
- 2. Eoof edhge border
- 3. Sliding box
- 4. Capping
- 5. Soldered seam
- 6. Anchor point
- 7. Toothed anchor
- 8. T-anchor

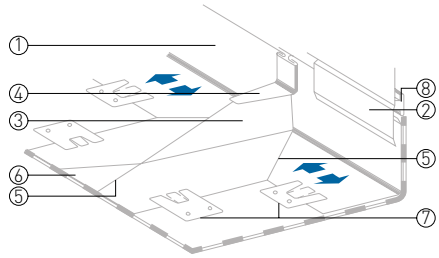

Dilatations for wall connection

- 1. Wall connection
- 2. Connecting strip
- 3. Sliding box
- 9. Capping
- 10. Soldered seam
- 11. Anchor point
- 12. Toothed anchor
- 4. Wall rail

06.9. SUBSTRUCTURE, PROFILES FOR BORDERS AND FLASHINGS

Basically various types of substructure are possible; the precondition is however always, that the substructure is sufficiently stable, contains no corrosive constituents, retains its shape and is resistant when wet and that the anchors can be attached sufficiently securely.

Formwork is made of dry (30% humidity) soft wood, rough sawn, squared, at least 24 mm thick, plank width 8 - 14 cm.

Large-scale wood-based panels with sufficient thickness (stability) and weather resistance are also frequently used.

06.9.1. PROFILES

Stop profiles: Continuous stop plates should be provided. They are made of angled titanium zinc (at least 0.8 mm, under normal circumstances 1.0 mm or under particular stress 1.2 mm) or galvanized steel sheet (0.8 mm or 1.0 mm). Stop plates hold the capping down at drip edges, thus providing good edge- and surface stability and permitting thermal length changes.

Depending on the width of the surfaces to be covered they are attached at both sides in the edging region or overlap to the full width of the wall coping. They are attached to the substructure by nailing or screwing to the nail batten or by screw anchors.

Mounting bracket, panel support: There are mounting brackets and panel supports made of galvanized steel sheet in different designs and sizes for titanium zinc roof borders. Their special design lets you compensate for horizontal and vertical structural and measurement differences. They are suitable for hot and cold roof designs. Special tensioning elements permit quick and easy assembly of the edge panels.

Capping holders: For titanium zinc wall claddings there are brackets with special cam fasteners which are clamped from below after hooking onto the capping plates so that the attachment is not visible.

The cams must be sufficiently stable to ensure that the capping cannot not work loose even in constant temperature movements.

Wall rails: wall rails or suspension profiles are used for the neat attachment of cap plates (overhangs). There are special versions available depending on the type of wall to which they are connected (brick, plaster, concrete). Matching sealing profiles are supplied as special accessories.

Corner brackets: prefabricated brackets for internal- and external corners make assembly quicker and easier. They are supplied by specialist dealers or made by hand to fit the different profiles.

06.9.2. SEPARATION LAYER, PROTECTING COATING

Separation layers: The specialist regulations specify intermediate layers to counteract aggressive influences from adjacent building materials e.g. prevention of alkaline attack from fresh mortar etc.

Separation can also be achieved by suitable protective coatings.

Titanium zinc angle strips for wall connections, terrace claddings etc. must be flush with the top edge of the cladding or even better, up to 2 cm above the surface of the terrace cladding or gravel and provided with a protective coating.

This also applies for all other sheet metal construction elements in the water-flow region beneath unprotected bituminous surfaces.



07.

ROOF DRAINAGE
MADE OF
TITANIUM ZINC

07.1. GUTTERS

07.1.1. TYPES OF GUTTERS MADE OF TITANIUM ZINC

The roof gutter is the part of the roof drainage system whose task is to collect precipitate falling on the roof from the connected roof surfaces and to guide it to the designated down pipes. According to the standard it is an open, trough-like profile, generally with front and rear reinforcement in the form of beading and water folds.

Gutters are either, depending on the installation situation

- external off-the wall gutters
- external gutters, supported on ledges
- external gutters, however e.g. behind a fascia like an internal gutter in the building
- internal gutters, within the building
- Roof-mounted gutters

Further differentiation is made according to the shape, i.e. half-round and square gutters or special gutters and according to the type of mounting, i.e. suspended, vertical and horizontal gutters and special attachments.

By far the most common are external, half-round or square off-the-wall gutters.

Suspended gutter



Outer (ledge-) gutter

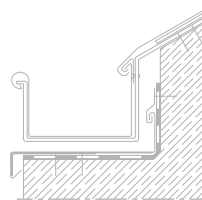

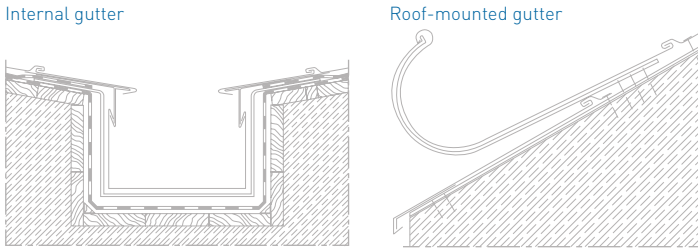

In general internal gutters, because of the substantially higher risk with respect to material selection, making and structural location, must be more carefully designed than external gutters.

This is described in the section “Special features of internal gutters”.

07.1.2. SHAPES AND DIMENSIONS OF ROOF GUTTERS

Until 1995 the dimensions of gutters and downpipes were nationally exactly defined (in Germany in DIN 18461). The DIN includes all relevant shapes and designs and defines the dimensioning requirements for all materials.

For transfer of the national standards for roof drainage components into European standards (EN's), it was not possible to list all the standard European shapes and dimensions in the standard, therefore DIN EN 612 gives only minimum values for the main dimensions.

This means that there is no exact legal “Nominal value xx according to DIN EN 612”. The required gutter must be described fully in terms of shape, precise measurements and dimensions.

Since this is very time consuming and the “old” dimensions are tried and tested in the German-speaking region the tried and tested dimensions are still employed - with minor adjustments - and can be ordered and specified as such.

NOMINAL SIZE	d_h d_v [mm]	d_2 [mm]	e [mm]	f min.	g [mm]	Nominal thickness [mm]	Cross section [cm ²]
200	16	80	5	8	5	0,65	25
250	18	105	7	10	5	0,65	43
280	18	127	7	11	6	0,70	63
333	20	153	9	11	6	0,70	92
400	22	192	9	11	6	0,80	145
500	22	250	9	21	6	0,80	245

Table 20: half-round roof gutter, "standard dimensions"
(d_h , d_v , and d_2 are external values)

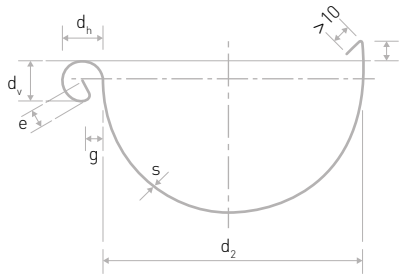

NOMINAL SIZE	d_h d_v [mm]	a [mm]	b [mm]	e [mm]	f min.	g [mm]	Nominal thickness [mm]	Cross section [cm ²]
200	16	42	70	5	8	5	0,65	28
250	18	55	85	7	10	5	0,65	42
333	20	75	120	9	10	6	0,70	90
400	22	90	150	9	10	6	0,80	135
500	22	110	200	9	20	6	0,80	220

Table 21: Square roof gutter "standard dimensions"
(d_h , d_v , and b are external values)

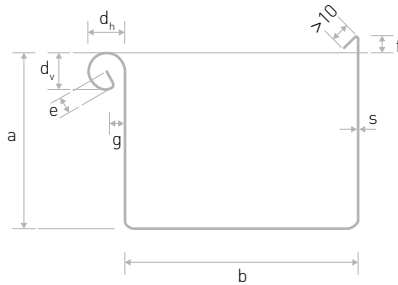

07.1.3. INSTALLATION OF GUTTERS, FALL

There are no exact regulations for the arrangement of gutters; the height of the roof surface, like the pitch, is subject to regional custom and experience, which is developed on the basis of the local climatic conditions.

Gutters should be arranged however such that as far as possible all the rainwater is collected from the whole of the roof surface. At the same time it is necessary to prevent stress caused by snow and ice slipping from the roof surfaces.

Basically gutters should be arranged in the gutter brackets such that the unhindered temperature change movements are permitted but wind forces cannot cause lifting of the gutter.

Gutters should also be installed with a slight fall of at least 1 mm/m, ideally 3 - 5 mm/m because this permits faster drainage of the rainwater and thus removal of impurities and dust.

The requirement to fit gutters with a minimum drop however has not been included in the standard since the end of the 70s so a “zero degree pitch” is not impossible. It is recommended nevertheless to maintain a certain fall.

Totally horizontal gutters tend to block and require more maintenance. If the fall is perceived as a visual flaw, it can be concealed by means of gutter cladding.

In the case of external gutters the rear edge of the gutter must be 10 to 15 mm higher than the front edge, to allow excess water to drain out from the front without wetting the structure.

Under certain circumstances valley gutters require additional measures e.g. increased cross section, additional downpipes, emergency overflows, safety gutters etc. (see “Special features of internal gutters”).

07.1.4. CONNECTING GUTTERS

The connections between the gutters and between the gutters and additional parts depend on the material. Gutters made of titanium zinc are basically soldered.

Titanium zinc gutters are soldered at the join, at the base of the gutter and at the gutter suspension supports and at other connecting points. There is special flux for pre-weathered gutters made of elZinc® titanium zinc so that “normal” solders can be used.

Adhesives have been developed as connection techniques have been refined which guarantee sufficient tightness if used correctly. The standard method for titanium zinc however is soldering.

The solder must have joined to parts to be connected at a width of at least 10 mm. The gutter length for suspended roof gutters with a cutting size of < 500 mm, in other words standard gutters according to Table 11, limited according to the specialist regulations to 15 m.

With cutting sizes starting from 400mm and with thicker sheets, pre-tinning of the overlap is recommended and if necessary riveting to secure the assembly before soldering. Rivets are then soldered over.

07.1.5. CONNECTION TO THE ROOF COVER, EAVES DESIGN

The transition between the roof covering and the gutter is formed by the eaves strips (gutter suspension plate). The eaves strip acts as a gutter inlet (guiding the rainwater to the gutter) or a drip plate (to guide the rainwater away if the eaves plate is not used for gutter suspension or is generally used to protect the substructure).

The installation of eaves strip is not generally specified; there are regional differences. Eaves plates are either basically included or normally left out. Use depends on the roof pitch and overhang, the location of the gutter and the installation situation. Depending on the installation situation of the gutter the eaves strip can practically continue into the roof pitch or be angled from the eaves angle to almost vertically downwards.

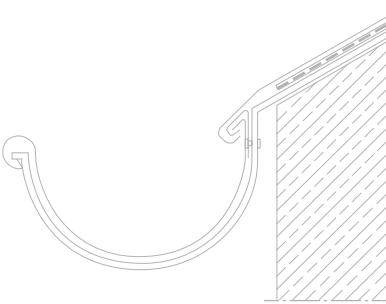

The eaves strip covers the gutter bracket fastening and the gutter board and is hooked into the water fold

In flat or almost flat roofs with bituminous or film sealing an eaves strip is specified for sealing the edge of a roof according to the technical regulations of the German Roofing Association. This must be soldered based on the special requirements for tightness under stress, wherein in particular, dilatations (e.g. Neopren Dilas) must be soldered in place at intervals.

Attachment is via anchor or bitumen, wherein in each case sufficient expansion opportunity must be included based on the temperature-related length changes.

With steeper roofs the use of non-soldered eaves strips is recommended. These are preferably designed as overlapping (not soldered) eaves strips and attached with anchors (up to approx. 3 m length).

In exceptional cases and particularly in shorter eaves strips (up to approx. 1 m length) they can even be nailed to the pitched roof if attaching anchors is too time-consuming.

CUTTING WIDTH	NOMINAL SHEET THICKNESS
167 mm	0,7 mm
200 mm	0,7 mm
250 mm	0,7 / 0,8 mm
> 250 mm	0,8 / 1 mm

Table 22: Guideline values for cutting widths and plate thickness of eaves strips

The upper overlap of the eaves strip is based on the roof pitch, covering material and local and climatic conditions. Depending on the design of the eaves, site and roof type larger cutting widths of the eaves strips may be required.

07.1.6. GUTTER BRACKETS

Gutter brackets are used to attach the roof gutter to the structure; the assembly depends on the type of roof construction. They are supplied in standard sizes to fit half-round and box-shape gutters. Gutter brackets are divided into those with two springs and those with one spring and a “latch”. Dimensions and installation spacing depend on the type of load.

Gutter brackets can be made according to EN 1462 of corrosion-protected flat steel (galvanised steel strip or hot dip galvanised narrow strip). For gutters made of pre-weathered titanium zinc there are also gutter brackets made of hot dip galvanised steel strip with additional (coloured) plastic coating (duplex system).

Tables 19 and 20 (overleaf) give the dimensions of the gutter brackets for “gutter dimensions according to advise from ZINC” (see Tables 14, 15, p. 48). These standard sizes are selected according to the gutter bracket spacing (in accordance with assembly onto the gutter board or rafter spacing) and according to the load. In snowy regions only the

higher stress series are used.

To reinforce the gutter bracket to prevent to gutter from bending it is regionally usual to use “expanding” gutter brackets, in other words with a tension strip over the gutter opening which grips the beading such that the beading cannot push forward even under high loads. This tension strip can be attached either to the gutter brackets or separately from the gutter brackets to the gutter board.

GUTTER BRACKET SPACING	NORMAL STRESS	HIGH STRESS (SNOWY REGIONS)
700 mm	Reihe 1	Reihe 3
800 mm	Reihe 2	Reihe 4
900 mm	Reihe 3	nicht zulässig

Table 23: Stress group depending on bracket spacing and load

Planners should state the load series for the gutter brackets in the invitation to tender and thereby define the spacing of fastening points (=number of required gutter brackets).

Installation of the gutter brackets

Depending on the type of eaves design, gutter boards, eaves formwork, rafters or assembly timbers are needed for attachment of the gutter brackets, which are secured with **at least two suitable corrosion-protected nails or screws**. To ensure the escape and/or the fall of the roof gutter the gutter brackets are carefully aligned before finally attaching.

If the roof construction requires (e.g. in the case of metal roofs), the gutter brackets are to be fitted flush to the gutter board or -formwork. The installation spacings depend on the local conditions and on the expected snow load.

07.2. SPECIAL FEATURES OF INTERNAL GUTTERS

Internal gutters travel within the building surface within the roof ceiling area and thereby represent a part of the roof skin. They therefore require particularly careful detail planning.

To prevent water from penetrating the building interior with increased precipitation, two downpipes should be provided for safety reasons, of which each must have a mathematically adequate cross section for drainage of the connected roof surfaces. Another option is the arrangement of emergency overflows, which must be mathematically verified.

This ensures that if a downpipe is blocked, rain water will still be completely drained away.

If there is a risk that the water flow may be impeded by melting ice and snow, particularly in the case of internal gutters with a large cross section, auxiliary **gutter heating** must be provided. Gutters are heated by insulated heating cables with a specific output of 30 - 60 W/m, which must be fitted in the gutter and the downpipe. The gutter heating can be thermostat-controlled or manually switched.

07.2.1. VENTILATION, HEAT INSULATION OF VALLEY GUTTERS

Condensate from residual building moisture and useful moisture can collect in the absence of adequate ventilation of internal gutters on the underside of the metal.

When designing the rear ventilation for the gutter there must be at least 20 cm free height of the flow through the airspace unless the flow has been mathematically validated. The heat insulation lies on the bare roof and may not block the ventilation space.

07.3. SNOW GUARD, SNOW-SLIP PROTECTION

In snowy regions it is normal to fit snow guards to keep the eaves area free from slipping snow masses, which could overload the gutter suspended below and to prevent large masses of frozen snow from falling down.

Local building regulations may have binding rules for the arrangement of snow guards.

Depending on the roof construction different design types may be used, wherein the material is always selected to suit the roof covering and the gutter; in this case contact corrosion issues (see Section 2 and Table 2) should also be noted. Snow guards above titanium zinc gutters are made of hot-dip galvanized or non-rusting steel.

07.4. ACCESSORIES FOR GUTTERS; TERMS, SHORT EXPLANATIONS

Gutter brackets are used for attaching the roof gutter to the structure. Assembly is according to the type of roof construction; different designs are common to various regions e.g. with “expansion” (structural stiffening).

Gutter fall: it is recommended to fit gutters with a fall of 3 to 5 mm/m to the outlet. It is however admissible to fit gutters without a fall (“with zero-degree fall”) but this requires more intensive cleaning.

Eaves strips (gutter suspension plates) form the connection between the roof covering and the roof gutter.

Gutter end caps are required for the ends of the gutter and fit the gutter profile. Some versions are soldered and others have a seam connection with the gutter.

Gutter bends are connecting pieces for when the gutter changes direction. They are designed to fit the profile of the adjoining gutter stretch. 90° gutter bends are industrially produced and supplied or made by hand to fit the roof gutter shapes. Hand-made versions need to have a sufficiently wide solder connection.

Dilatations (sliding seams) are required to accommodate thermal length changes. Expansion elements (“Dilas”) made of Neoprene are fitted in internal gutters so that the water drainage via the gutter is not impeded.

Gutter outlets are the transition pieces which connect the roof gutter and the rain downpipe in different shapes and versions.

Protective guards/leaf guards over gutter outlets or as leaf guards over the whole length of the gutter should prevent leaves etc. from blocking the downpipe- or gutter without affecting the water drainage. They also prevent birds from nesting in the gutters. They should be regularly cleaned otherwise they do more harm than good.

Sample photos (not really reflect reality, they are just examples)

Gutter heaters prevent the gutter from icing over in frost and when the thaw sets in they prevent frozen snow and ice from blocking the water flow.

Snow guards prevent large quantities of snow from slipping and blocking the gutter in some cases or causing damage by imposing excessive loads.

07.5. TITANIUM ZINC DOWNPIPES

07.5.1. DESIGN TYPES

Downpipes made of titanium zinc are manufactured according to EN 612. Cylindrical downpipes (Ø 60 mm to Ø150 mm) and square downpipes (60 x 60 mm² to 120 x 120 mm²) are the most common.

NOMINAL SIZE	DIAMETER (INTERNAL) [mm]	CROSS SECTION AREA [≈ cm ²]	NOMINAL THICKNESS [mm]	ASSOCIATED GUTTER
60	60	28	0,65	NG 200
76 ¹	76	45	0,65	NG 250
80	80	50	0,65	NG 250/280
87 ¹	87	59	0,65	NG 280
100	100	79	0,65	NG 333
120	120	113	0,70	NG 400
150	150	177	0,70	NG 500

Table 24: Cylindrical downpipes, standard dimensions

NOMINAL SIZE	DIAMETER (INTERNAL) [mm]	CROSS SECTION AREA [≈ cm ²]	NOMINAL THICKNESS [mm]	ASSOCIATED GUTTER
60	60 x 60	36	0,65	NG 200
80	80 x 80	64	0,65	NG 250
95 ¹	95 x 95	90	0,70	NG 333
100	100 x 100	100	0,70	NG 333
120	120 x 120	144	0,80	NG 400/500

Table 25: Square downpipes, standard dimensions

¹Regional (still) standard ratings

07.5.2. INSTALLATION INSTRUCTIONS

Downpipes are to be at least 20 mm away from the finished wall and should lead vertically downwards as far as possible without direction change. Standard prefabricated parts such as gutter supports or hoppers, pipe bends or angled pipes are used as transitions from the gutter to the downpipe.

They are attached to the building using pipe clips (accessories). The distance between the pipe clips up to the nominal size of 100 may not exceed 3.0 m and in the case of larger falls (> 100) may not be greater than 2.0 m.

The downpipe should be attached to the pipe clips to prevent them from slipping. In the case of welded pipes it is possible to situate the pipe clips directly below the wider pipe socket section. In the case of other pipes under certain circumstances pipe beads can be soldered on (accessory) above the pipe clamp to prevent the pipe from slipping.

The downpipes are connected with push-fit connectors if there are different upper and lower pipe widths or a sleeve joint (welded pipes).

In the case of purely cylindrical down pipes (e.g. welded pipes cut to length) socket fittings must be used for connection or the bottom ends of the pipes must be fitted by hand. Push-fit connections must have at least 50 mm of pipe inserted into the other. Soldering is not required for connection of rain downpipes.

The connection to the standpipe should be easy to release. Connectors for the downpipe connection in standard sizes are ideal (prefabricated parts). The use of titanium zinc downpipes for standpipes in contact with the earth is not admissible. Due to the thicker material, great stability and visual similarity, in areas in contact with the earth it is recommended to use hot galvanized standpipes.

07.5.3. ACCESSORIES FOR RAIN DOWNPIPES; TERMS, SHORT EXPLANATION

Gutter outlets form the connection between the gutter and the downpipe; they are supplied to fit all half-round gutters offer and have a circular connector which inserts into the top end of the vertical downpipe or pipe bend (insertion length up to Nominal Size 80 min. 35 mm, for NS 80 min. 40 mm, NS 100 min. 45 mm, above that at least 50 mm). There are also connectors with oblique outlets to fit angled pipes.

Solder sleeves are soldered into an opening in the base of the gutter to connect square gutters to the downpipe.

Hopper boxes act in the same way as gutter outlets. However, while outlets attach around the outside of the gutter, the gutters feed from the side into the normally square hopper boxes and form a free outlet in the large volume interior of the hopper.

Pipe bends for round and pipe elbows for square downpipes are used to connect downpipes which change direction. They are supplied as standard with 40°, 60° and 72° angles. The insert length up to Nominal Size 80 is at least 30 mm, from NS 80 to 100 at least 35 mm, thereafter at least 40 mm. The nominal sheet thickness complies with that of the corresponding downpipe.

Angled pipe as tapered connection between roof gutter and downpipe. For use with gutter outlet sleeves (S-shape) and pipe bends (40°) in the case of larger roof overhang.

Pipe clips are used to attach the downpipes to the structure. They are made of hot-dip galvanised steel strip with expansion peg or screw peg and screw anchor. Individually galvanized versions are also common (DIN EN ISO 1461). The downpipes are attached with pipe clips which must not constrict the thermal length changes. However, to prevent the pipes from slipping out, pipe beading or lugs can be attached above the pipe clips.

Soldered beading or lugs to prevent slippage of downpipes in the pipe clips.

Standpipe connector (standpipe cap) as transition between downpipe and standpipe.

Standpipe: part of the subsequent water drainage system. Downpipes may not lie in the ground. They must be connected to stable, corrosion-protected pipes when they reach the ground, e.g. hot-galvanised steel pipes.

Pipe outlet as curved or angled end piece, if not connected to the main drain system (corresponds to shoe bend, e.g. for drainage of dormers directly onto the roof surface).

Rain pipe tap as a moveable intermediate piece for the occasional tapping of water (with and without leaf guard) e.g. for use of the rainwater for watering garden.

Through-feed pipe to create a through-feed if a ledge projects outward by a long way. The rain downpipe is fed through the through-feed pipe. A suitable seal (cap) is fitted above the through-feed pipe.

07.6. DIMENSIONING ROOF DRAINAGE SYSTEMS

07.6.1. GENERAL NOTES

Since January 2001 dimensioning has been regulated primarily by EN 12056 and EN 752, which has applied exclusively since 01.07.2001. In this case the hydraulic verifications, which have always been required for internal gutters [in special cases], have been extended to become binding for all roof drainage systems.

In practice this means that only in very simple cases can dimensioning take place on the basis of “rough calculations” using simple nomograms; generally even simple cases like off-the-wall gutters require serious mathematical calculations

07.6.2. DIMENSIONING OF ROOF DRAINS ACCORDING TO EN 12056- 3 AND DIN 1986-100

Dimensioning an off-the-wall or valley gutter must involve the following steps:

- Definition of the drainage concept, with determining of
 - Outflow to the (designed) outlets and rain downpipes
 - Drainage via overflow equipment (off-the-wall gutters: Overflowing of the gutter in “extreme circumstances” and/or emergency overflow systems e.g. hopper boxes)
- Determination of the rainfall using statistical data and (new !) taking into account the building use
- Calculation of rainwater outflows for all parts of the gutter, taking into account the “effective roof surface”, and if necessary taking into account the wind influences
- Distribution of influences in accordance with drainage concept
- Determination of the flow path lengths in each section of the gutter
- Dimensioning of the gutter cross section and determination of the pressure height at the downpipe outlet/infeed taking into account flow diversions (direction changes $>10^\circ$, e.g. gutter angles)
- Dimensioning of the outlet spout in combination with the downpipe and taking into account interruptions, e.g. strainers, leaf guards

Since the author of the standard knew that this extensive dimensioning [to be carried out for each gutter] makes things very complicated for those unused to the process, the standard contains “Flow diagrams for different calculations”.

The **flow diagrams for dimensioning** off-the-wall gutters and for dimensioning valley and inbuilt gutters are included in the appendix of EN12056-3. “In-built gutters” in this case are external gutters which are integrated “into the building” e.g. behind a fascia.

Bemessung innenliegender und eingebauter Dachrinnen sind im Anhang der EN 12056-3 aufgeführt. “Eingebaute Dachrinnen” sind hierbei außenliegende Rinnen, welche z.B. hinter einer Attika “in das Gebäude integriert sind”.

07.6.3. INSTRUCTIONS ON DIMENSIONING

Dimensioning is carried out in steps wherein the gutter and the outlet/downpipe situation are verified separately on the basis of the determined rainwater outflow. It is then determined whether the downpipe has sufficient outflow opportunities.

For rough dimensioning of off-the-wall gutters, without taking into account special cases or special influences, the following guideline values are specified for the most common half-round and square gutters NS 250 to NS 500 according to EN 612.

Adjacent roof surfaces in the case of off-the-wall gutters

The rainfall value is generally the 5-minute rainfall, which is exceeded once in 2 years (r 5/2). The centennial rainfall (r 5/100) is used for the overload situation.

The gutter outflow capacity is determined from the mathematical water level difference between the farthest point from the outflow and the water level height at the outflow, the area of the available gutter cross section, the gutter length and the type of outflow into the downpipe.

For gutters with no fall, in other words, with a fall of $< 4\text{mm/m}$, the rainwater flows and/or adjacent roof surfaces are listed in Tables 26 and 27. The “length” of the gutter in this case is the maximum distance between the end of the gutter and the outlet.

LEN-GTH [m]	NG 250			NG 333			NG 400			NG 500		
	Q	connectable roof surface in r= l/s ha		Q	connectable roof surface in r= l/s ha		Q	connectable roof surface in r= l/s ha		Q	connectable roof surface in r= l/s ha	
	[l/s]	300	400	[l/s]	300	400	[l/s]	300	400	[l/s]	300	400
< 5	1,07	36m ²	27m ²	2,64	88m ²	66m ²	4,63	154m ²	116m ²	8,66	289m ²	217m ²
7,5	1,02	35m ²	26m ²	2,54	84m ²	63m ²	4,48	149m ²	112m ²	8,59	286m ²	214m ²
10	0,97	32m ²	24m ²	2,45	82m ²	61m ²	4,35	145m ²	109m ²	8,35	278m ²	209m ²
15	0,88	29m ²	22m ²	2,28	76m ²	57m ²	4,10	137m ²	103m ²	7,97	266m ²	199m ²
20	0,80	27m ²	20m ²	2,12	71m ²	53m ²	3,87	129m ²	97m ²	7,60	253m ²	190m ²

Table 26: Outflow capacity Q (l/s) half-round gutters with normal dimensions and different lengths (flow paths to the outlet) and connectable roof surfaces in rainfall 300 l/s ha and 400 l/s ha:

LEN-GTH [m]	NG 250			NG 333			NG 400			NG 500		
	Q	connectable roof surface in r= l/s ha		Q	connectable roof surface in r= l/s ha		Q	connectable roof surface in r= l/s ha		Q	connectable roof surface in r= l/s ha	
	[l/s]	300	400	[l/s]	300	400	[l/s]	300	400	[l/s]	300	400
< 5	1,02	34m ²	26m ²	2,38	79m ²	59m ²	3,96	132m ²	99m ²	7,23	241m ²	181m ²
7,5	0,97	32m ²	24m ²	2,28	76m ²	56m ²	3,83	127m ²	95m ²	7,02	234m ²	175m ²
10	0,82	30m ²	23m ²	2,18	73m ²	55m ²	3,63	121m ²	91m ²	6,82	227m ²	172m ²
15	0,82	28m ²	20m ²	2,01	67m ²	50m ²	3,44	115m ²	86m ²	6,43	214m ²	161m ²
20	0,74	25m ²	19m ²	1,85	62m ²	46m ²	3,21	107m ²	80m ²	6,07	202m ²	152m ²

Table 27: Outflow capacity Q (l/s) half-round gutters with normal dimensions and different lengths (flow paths to the outlet) and connectable roof surfaces in rainfall 300 l/s ha and 400 l/s ha:

If the gutter changes direction in the direction of flow, e.g. gutter angles on house corners, the specified values in Tables 26 and 27 for the drainage capacity and/or for the connectable roof surface for each angle > 10° must be multiplied by the reduction factor 0.85.

Connectable roof surfaces depending on drainage through outlet / downpipe

In the calculation of the drainage capacity of the selected combination outlet / downpipe, differentiation is made between “overflow” and “drainage flow”.

Note that, based on the relationship between the downpipe size / nominal size of the gutter (see Tables 24 and 25) the whole system including the gutter must be reassessed if it appears that the drainage capacity of the combination outlet / downpipe is too small.

The determining size of the maximum drainage capacity and with it the critical point of a drainage system is the outlet.

In gutters with flow-favouring transitions (tapered gutter attachment) from the roof gutter to the outlet and of an aperture in the base of the gutter which is around double the size of the smallest cross section of the downpipe the drainage capacity of the gutter outflow can be assumed to be about the same.

Drainage capacity of vertical rainwater downpipes

INTERNAL DIAMETER (CIRCULAR ~ SQUARE)	DRAINAGE CAPACITY AT FILL LEVEL $F = 0,33$
60 mm; 60 x 60 mm ²	2,7 l/s
80 mm; 80 x 80 mm ²	5,9 l/s
100 mm; 100 x 100 mm ²	10,7 l/s
120 mm; 120 x 120 mm ²	17,4 l/s
150 mm	31,6 l/s

Table 28: Drainage capacity Q (l/s) of vertical downpipes

In the case of complicated relationships or if the roof surfaces to be connected lie in the limit region of the rough calculation, dimensioning should always be carried out by a specialist engineer.



08.

PROCESSING

elZinc[®]-TITANIUM

ZINC SHEET AND

elZinc[®] TITANIUM

ZINC COMPONENTS

elZinc® titanium zinc is optimized for processing. elZinc® titanium zinc and the products made of elZinc® titanium zinc can be worked using all manual and mechanical methods and can be adjusted to any shape irrespective of the rolling direction

08.1. BASIC INFORMATION ON FASTENING AND CONNECTING

Fasteners and connections in roofs and facades depend on the loads in their different areas, wherein edges and corners are exposed to particular stresses.

There are two basic fastening types for the assembly of titanium zinc sheet and components: indirect and direct.

The **indirect fastening** is a movable or expansion-compensating connection which is designed, for instance by means of anchors and anchor strips, by means of stop plates or angles to secure edges, cappings or closures.

A **direct fastening** is a rigid, immobile connection to the lower layer of the roof by means of roofing nails, screws, nails or clips.

In principle, gluing with permanently elastic adhesives is viewed as a quasi-rigid, direct connection, because it does not permit unlimited movement to compensate for temperature induced expansion.

Irrespective of which type of fastening is used for a particular component, unhindered movement to compensate for temperature expansion must be guaranteed.

For some construction elements such as gutters, cappings and valley connections there are special ready-made dilatations which are incorporated into the construction elements. However there are also precise specifications for maximum distances for structural expansion options, which are formed by the design of the construction elements.

The spacings specified in Table 11 for dilatations apply only for extended lengths; in the case of hindered movement e.g. at corners or height differences, the values should be respectively halved.

08.2. GLUING TITANIUM ZINC WITH ADHESIVE COMPOUND

It has been demonstrated that titanium zinc components can be glued with suitable adhesive compounds which have been tested for that purpose in horizontal and pitched areas such as window strips and wall copings, and as additional full-surface attachment in vertical areas, such as flashing or cladding.

Suitable adhesive compounds are permanently-plastic bitumen-based adhesives which contain fast evaporating solvents, adhesive resins, bonding agents, UV absorbers, antioxidants, fibre- and active fillers. They can be used at temperatures of +5°C to +30°C. Thanks to the residual elasticity, thermal reciprocations of the glued metal parts are possible within certain limits.

The good adhesiveness guarantees a fixed bond of the elZinc® construction elements on cement, concrete, brick, wood-based panels etc. The use of adhesive compounds requires an even, firm subbase which must be clean, free from dust and dry.

Newly glued joints of overhanging cappings are vulnerable at corners. Therefore they require additional mechanical securing to withstand the potentially high peeling forces (design as anchor point).

Processing:

The adhesive compound is applied with a groove scraper. Bitumen adhesive loses adhesiveness and should not be used in outside temperatures of less than + 5°C.

Adhesive compounds stored too cold can be heated in a water bath. Note that the titanium zinc sheet to which the adhesive is being applied also must not be colder than 5°C. The maximum temperature for processing in the summer is approx. 30°C (adhesive compound-temperature) and approx. 50°C in the case of elZinc titanium zinc plate components. The average consumption on an even subbase is approx. 2 to 3 kg adhesive/m².

08.3. SOLDERING (SOFT SOLDERING)

This substance-to-substance joining process for the watertight connection of elZinc® titanium zinc is produced using standardized fluxes and solders. The metal surface must be bright-finished.

Very dirty or oily surfaces due to lubricant and coolant traces from the rolling process must be degreased because the solder will not adhere to greasy surfaces and the connection will not be reliable.

Thick layers of oxide- and dirt should also be mechanically removed by scraper or sanding.

Flux (EN 29 454-1) should guarantee sufficient cleaning and wetting of the metal surface and exclude oxygen from the soldering process. For safety reasons use of the formerly frequently-used hydrochloric acid cannot be recommended.

Special fluxes are used for pre-weathered elZinc® titanium zinc which are adapted for the patination and can penetrate this layer.

Lead-tin soft solder with 40% tin according to EN 29453 - LPb Sn 40 (antimony-free) is recommended, because it offers optimum gap filling, good wetting and high strength. The melting range of this solder is 183 to 235°C. For titanium zinc materials at least low-antimony solder is specified. Low antimony solder is labelled "(Sb)".

Soldering is carried out with as large a soldering iron as possible. Its weight may not be less than 350 g. A soldering iron weighing 500 g guarantees good heat retention without the danger of overheating. A broad contact surface is recommended for rapid heat transfer to the solder joint.

The solder gap width may not exceed 0.5 mm to ensure good seam strength. The minimum overlap (=bonded soldered seam) must be 10 mm according to the standard requirements and specialist regulations in horizontal areas and at least 5 mm in vertical joins.

If soldering components with wide section and a plate thickness of more than 0.8 mm, pre-tinning of the soldered seam is recommended as it gives better adhesion. For difficult soldering joints, where the solder gap cannot be fixed in any other way, the joint can be secured before soldering using rivets, which are then incorporated in the solder.

Immediately after soldering, remove excess flux with a clean damp because any remains of flux can become slightly corrosive when wet (dew, condensates, light rain) and can form unsightly marks on the titanium zinc.

The soldering iron must be cleaned from time to time so that the thermal conductivity does not deteriorate. To reduce the oxidation of the soldering iron, you can tin the smoothed and cleaned areas of the fin using a salmiak stone with the addition of tin solder.

08.4. WELDING

elZinc® titanium zinc is effectively welded using a suitable method. Welding is used as a joining means particularly in the mechanical production of titanium zinc parts such as rain downpipes, gutter outlets etc. In this joining process, the material-specific properties of the titanium zinc low melting point, high tendency to form oxidizing layers- are to be taken into account.

Suitable methods have been developed which offer specific benefits for different applications. WIG welding with DC with normal sheet thickness achieves a high welding rate of 10 to 15 m/min.

WIG welding with AC has the advantage that this method is relatively insensitive to surface contaminants. The use of AC during welding has a certain self-cleaning effect which reduces the formation of oxide layers, but this should not be overestimated and considered as the sole cleaning method. In this method the disadvantage is the relatively low welding speed of 5 m/min. with the usual sheet thickness of 0.65 mm to 1.0 mm.

High-frequency welding combines very high welding speeds with high strength but requires very precise parameter-settings.

If welding titanium zinc you should always note that this is a very specialized process. The welding equipment therefore should always be set up by corresponding trained personnel who understand process engineering as well as the material characteristics.

08.5. SCREWS, RIVETS

Screw fastening of titanium zinc sheet only occurs in exceptional cases. The screw geometry, length and diameter must be in accordance with the components to be connected.

The connection of titanium zinc sheet by rivets creates a positively-engaging connection. It is characterized by the accuracy of fit of the pre-drilled holes and the diameter of the rivet.

This form of connection acts predominantly to secure components. Rivets must be soldered after riveting to create a watertight connection. Another way of obtaining a watertight design is to produce two rows of offset rivets with a sealed inlay.

08.6. STAPLES, NAILS

Staples can be used in place of screws or nails to attach the anchors. In this case there are particular requirements for the staples and the timber substructure.

The staples must be non-magnetic and made of stainless steel wire with a wire cross section of 1.5 mm, approved by the German institute for construction engineering (DIBt).

The ends of the staples - the ends of the wire should be saw-tooth by design - have an influence on the anchoring in the wood and the extraction values. Per connection at least three staples should be inserted flush obliquely or longitudinally and/or at right angles to the surface of the secured component, or at least 45° to the grain of the timber planking.

A minimum spacing of 5 - 8 mm must be maintained between the individual staples. In timber substructures it should be noted that the pull-out resistance of the staples depends heavily on the wood humidity. Therefore in the case of wood humidity of over 25%, nails or screws or a larger number of staples are recommended.

Corrosion-protected nails (grooved nails, flat headed nails, roofing nails) are suitable for direct attachment. Anchors secured with two nails have an average extraction value of 560 N. The nails can be manually hammered into the wood or inserted with a nail gun.



09.

SURFACE FINISHES
OF elZinc®
TITANIUM ZINC

The different influences on the surface oxidation process.

09.1. DIFFERENT TYPES OF COMPONENT – DIFFERENT EXPOSURES

The surface finish of elZinc® titanium zinc depends amongst other things on the weathering of the surface.

The different pitches of roofs and façades also mean that surfaces weather differently. Rain runs off steeper pitched surfaces far faster than off flatter ones. Therefore more dirt remains even on roofs with a slight pitch and can cause the surface to change.

Façades are often only partly covered by roof overhangs and facade projections. The surface therefore weathers unevenly with the result that the surface patination can develop variably. There are interim phases in which bright metal areas lie next to darkened matt-grey areas. These are often incorrectly described as “marking” or “discoloration”.

You should always consider therefore using pre-weathered elZinc® titanium zinc in a facade. This has the advantage that the facade always has a uniform surface even if unevenly weathered.

09.2. DIFFERENT LOCATIONS – DIFFERENT TYPES OF AIR

Depending on the geographical location of the construction project, different local atmospheric conditions also exist.

In an area of high air pollution, dirt particles attach to the surface of the elZinc® titanium zinc and react with the material. Depending on the exposure these are then washed away by the rain at different rates and can cause stronger reactions in some areas than in others. This causes inhomogeneous weathering of the surface. Sometimes “marks” and “discoloration” occur as described in 9.1.

elZinc® titanium zinc is basically suitable for use in coastal regions. A specialist planner should be involved however if weather conditions are unusual.

Normal contact with sea spray is not critical as this will have only superficial effects. Ensure however that salt encrustation cannot develop as this has a particularly aggressive effect on the titanium-zinc and can even cause total corrosion of the sheet.

Areas shielded from the rain are particularly vulnerable in this case because the rain cannot wash away the salty sea spray and this will affect the surface over time. These areas then need to be regularly cleaned and any prevailing salt encrustations immediately removed.

09.3. DIFFERENT COMPASS DIRECTIONS – DIFFERENT WEATHERING TIMES

The prevailing main wind directions in Central and Southern Europe mean that the weathering rate of elZinc® titanium zinc is usually somewhat higher in West and South facing facades than in North and East facing facades.

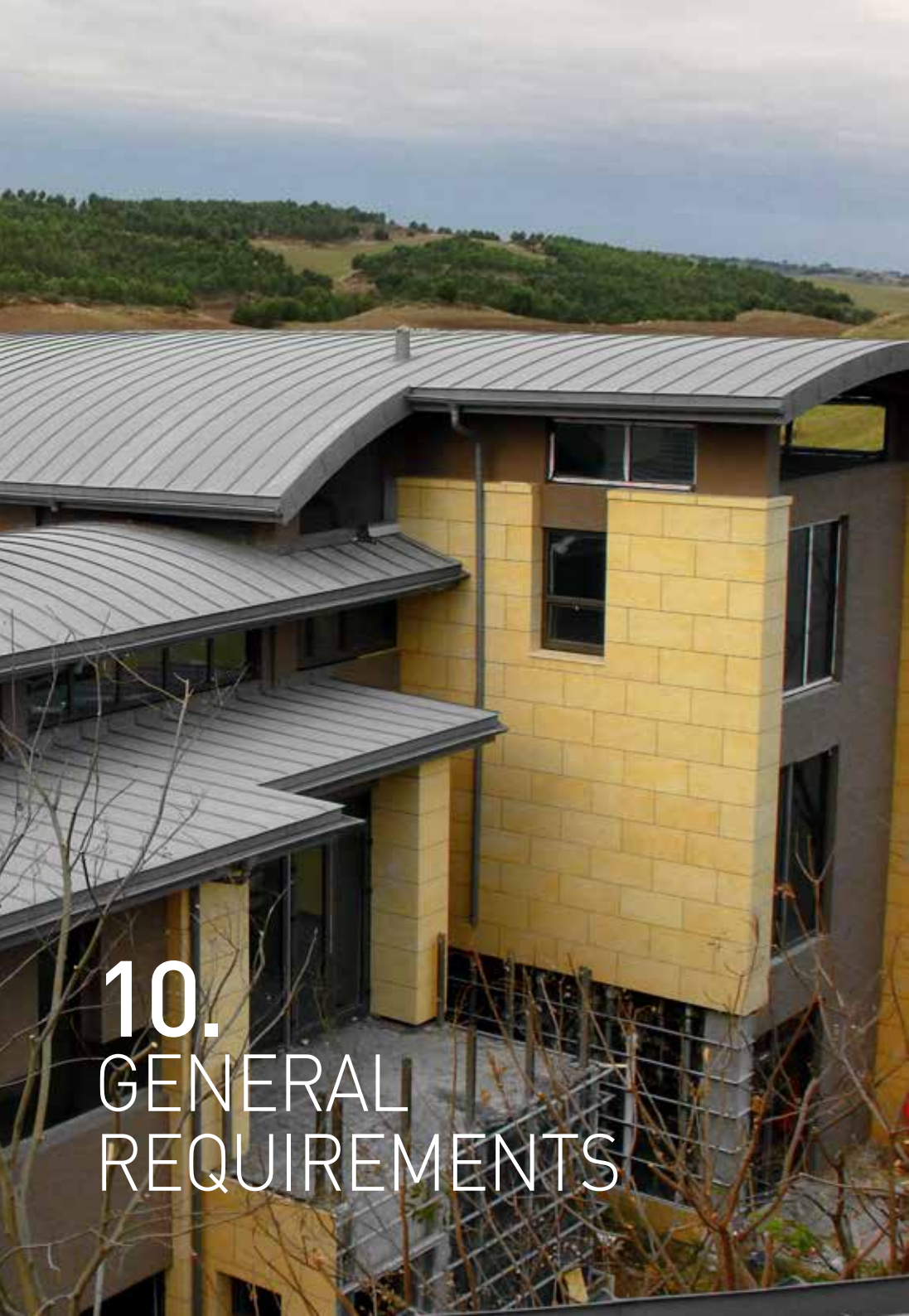

10. GENERAL REQUIREMENTS

Roofing works with elZinc® titanium zinc

The required plate thickness depends on the size, the cutting width, the shape, the fastening, the substructure and the material used.

In roof pitches of less than 3° (5%) the longitudinal seams of standing seam roofs should also be sealed.

The roof pitch of standing seam roofs must be at least 3° (5%) and in the case of roof pitches of up to 15° (27%) separation layers with drainage function shall be used.

Standing seam roofs shall be made vertically to the eaves and using the double lock standing seam system of height at least 23 mm unless otherwise specified.

Titanium zinc must be worked according to the standardised regulations at metal temperatures above 10 °C. At low temperatures titanium zinc should be heated.

Connections and fasteners must be designed such that the construction elements can expand and contract when the temperature changes without damage. In this case a temperature difference of 100 C is assumed, in other words from –20°C to +80°C (thermal extension: 2.2 mm/m).

Roof edges, wall claddings and connections should be applied with concealed corrosion-proof fastening elements.

Cappings, flashing and lower facade edges shall have a drip ledge with min. 20 mm distance from the building component being protected.

Cap plates should be secured at least every 250 mm, wall connection-rails at least every 200 mm. The minimum thickness for extruded profiles (cap plates) is 1.5 mm.

Roof gutter brackets shall be fitted flush into formwork and attached with countersunk fasteners.

elZinc® titanium zinc wall claddings

Wall claddings, unless otherwise expressly specified, must be made of vertically aligned strips with single lock seams.

Rear ventilated external wall claddings must comply with DIN 18516-1 “External wall claddings, rear -ventilated – part 1. Requirements, test principles.”

Substructures must be flush and perpendicular - adapted to bay work.

Edges of sheet metal less than 1 mm thick must be folded over and/or flattened.

Secondary performances, special performances

Secondary performances which are not billed separately are particularly:

Fitting- and dismantling and keeping scaffolding, whose working platforms may not be higher than 2 m above ground level or the floor. Marking cut-outs, slits and openings.

Recessing and attaching the gutter brackets, mountings for treads, anchoring elements, pipe clips.

Attaching, keeping and attaching of water deflectors for diverting rain water during the project. The water deflectors should extend at least 50 cm through the framework.

Special performances which are billed separately:

Measures for heating the sheet metal at low temperatures, precautions for working at low outside temperatures (sheet temperature < 10°C).

Maintaining accommodation and storage rooms if the client is unable to provide rooms which can be locked easily.

Fitting-, dismantling and keeping scaffolding, whose working platforms may be higher than 2 m above ground level or the floor. Conversion of scaffolding for the purposes of different contractors. Manufacture of remaining anchoring options in the structure e.g. for scaffolding.

Production of assembly- and installation plans.

Cleaning major dirt from the subbase, e.g. waste plaster, mortar, paint, oil if not caused by the contractor.

Smoothing out unevenness of the subbase if very uneven

Creation of the necessary height anchor points

Production of samples, sample surfaces, sample structures and models.

Supply of construction verifications and static calculations for verification of stability and the drawings required for this verification.

Proofs of structural safety, e.g. screw anchor extraction tests, concrete strength tests.

Cladding of reveals and drops and installation of window strips, ventilation grates and similar.

Use of profile strips or decorative panels, structural ornaments and the like.

Measures for diverting rainwater which exceed the normal requirements, e.g. manufacture of a temporary drain

Removal and replacement of rain downpipes unless the contractor is responsible for these.

Supply and installation of leaf and dirt guards in roof gutters or outlets.

Making and closing cut-outs, e.g. slits, screw anchor holes.

Fitting and removing roofs if the contractor is not responsible for this.

Dismantling and/or reassembly of components or claddings for performances of other contractors. Retrospective works and/or retrospective installation of parts.

Installation of internal- and external corners on formed sheet and sheet profiles.

Fitting mouldings to extruded profiles.

Installation of gutter angles, floor sections, outlet sleeves, hopper boxes, pipe bends and –elbows, tapered pipes or water tanks.

Installation of safety roof hooks, skylight cappings or mountings for treads.

Suitable precautions to be taken against lifting forces in wind and storm damage. Anchors, nails and screws are subject to the requirements in accordance with Table 3.

Brackets for roof edge borders and flashing in the roof area must be set in flush and countersunk screw fastened.

Connections on taller buildings should be raised by at least 150 mm at a roof pitch of up to 5° (9%) and at least 100 mm above the top of the roof surface at a roof pitch of more than 5° (9%) and flashed for rain proofing.

Graphic Design: Think diseño, comunicación & +
Legal Deposit: AS-0325-2012

© ASTURIANA DE LAMINADOS, S.A.

1st Edition 2012

All rights reserved. No part of this brochure may be published in any form, reproduced in extracts, translated or copied without the prior written permission of the issuer.



Factory:

Asturiana de Laminados S.A.

Polígono Industrial de Villallana, Parcela 1

33695 Villallana. Lena. Asturias. Spain

Tel +34 98 411 63 31 / +34 98 410 60 00

Fax +34 98 549 32 02

Head office:

Asturiana de Laminados S.A.

Polígono Industrial de Olloniego, Parcela C1

33660 Olloniego. Asturias. Spain

www.elzinc.es

elzinc@aslazinc.com